



FINAL REPORT

97-75/A-26

PH-TKC

Boeing 757

24 December 1997

Amsterdam Airport Schiphol

N.B. Aan enkele hoofdstukken in dit rapport is een Nederlandse vertaling toegevoegd. Het betreft hier de hoofdstukken 3, 4 en 5. Bij verschil in interpretatie dient de Engelse tekst als bindend te worden beschouwd.

To some chapters of this report a Dutch translation is added. These are the chapters 3, 4 and 5. If there are differences in interpretation the English text prevails.



FINAL REPORT

The Dutch Transport Safety Board is an independent governmental organisation established by law to investigate and determine the cause or probable cause of accidents and incidents that occurred in the transportation sectors pertaining to shipping, civil aviation, rail transport and road transport as well as underground logistic systems. The sole purpose of such investigation is to prevent accidents and incidents and if the Board finds it appropriate, to make safety recommendations. The organisation consists of the Transport Safety Board and a subdivision in Chambers for every transportation sector which are supported by a staff of investigators and a secretariat.

Members of the Dutch Transport
Safety Board:

Mr. Pieter van Vollenhoven Chairman

Mr. A.H. Brouwer-Korf

F.W.C. Castricum

J.A.M. Elias

Mr. J.A.M. Hendrikx

Mr. E.R. Müller

Prof.Dr. U. Rosenthal

Mr. E.M.A. Schmitz

L.W. Snoek

J. Stekelenburg

Prof.Dr. W.A. Wagenaar

Secretariat:

J. Goslinga

Drs. J.H. Pongers

Members of the Aviation
Chamber:

Mr. E.R. Müller Chairman

L.W. Snoek Vice-Chairman

C. Barendregt

Ir. H. Benedictus

H.P. Corssmit

J. Hofstra

Ir. T. Peschier

Drs. J. Smit

Ir. M. van der Veen

Secretariat:

B.A. Groenendijk

Mr. H. Geut

Address:
Prins Clauslaan 18
2595 AJ The Hague
telephone (031) 70 333 7000

mail:
P.O. Box 95404
2509 CK The Hague
telefax (031) 70 333 7078

REPORT 97-75/A-26

Final report of the investigation into the probable cause of the accident with Transavia Boeing 757, registration PH-TKC, on December 24th, 1997 at Amsterdam Airport Schiphol.

In accordance with Annex 13 of the Convention of Chicago as well as the Directive 94/56/EC of 21 November 1994 establishing the fundamental principles governing the investigation of civil aviation accidents and incidents of the Council of the European Union, the purpose of an investigation conducted under the responsibility of the Dutch Transportation Safety Board is not to apportion blame or liability.

Chairman of the Board

A handwritten signature in black ink, appearing to read 'J. J. van der ...', written over a large, faint circular stamp.

Chairman of the Aviation Chamber

A handwritten signature in black ink, appearing to read 'P. ...', written over a large, faint circular stamp.

Den Haag, 11 November 1999

De Eindrapporten van de Raad voor de Transportveiligheid zijn openbaar.
Een ieder kan daarvan gratis een afschrift verkrijgen door schriftelijke bestelling bij
SDU Grafisch Bedrijf, Christoffel Plantijnstraat 2, Den Haag, of via telefax nr. 070 378 9744.

CONTENTS

ABBREVIATIONS

GENERAL INFORMATION OF THE ACCIDENT

THE INVESTIGATION

SYNOPSIS

1 FACTUAL INFORMATION

- 1.1 *History of the Flight*
- 1.2 *Injuries to Persons*
- 1.3 *Damage to Aircraft*
- 1.4 *Other Damage*
- 1.5 *Personnel Information*
 - 1.5.1 *The Cockpit Crew*
 - 1.5.2 *The Cabin Crew*
- 1.6 *Aircraft Information*
 - 1.6.1 *General*
 - 1.6.2 *Weight and Balance*
 - 1.6.3 *Transavia Operational Limitations and Procedures*
- 1.7 *Meteorological Information*
- 1.8 *Aids to Navigation*
- 1.9 *Communications and Recordings*
- 1.10 *Airport Information*
- 1.11 *Flight Recorders*
- 1.12 *Description of the Damage*
- 1.13 *Medical and Pathological Information*
- 1.14 *Fire*
- 1.15 *Survival Aspects*
- 1.16 *Tests and Research*
 - 1.16.1 *Determination of the landing loads*
 - 1.16.2 *Failure analysis of a Boeing 757 NLG wheel well*
 - 1.16.3 *Investigation into windshear at the time of the accident*
 - 1.16.4 *Exploratory study on transient effects from autoflight to manual flight during approach and landing under strong crosswind conditions*
 - 1.16.5 *Flight simulator test crosswind handling Boeing 757*
 - 1.16.6 *Safety aspects of aircraft operations in crosswind*

- 1.17 *Organizational and management information*
- 1.17.1 *Runway Allocation*
- 1.18 *Additional Information*
- 1.19 *Useful or Effective Investigation Techniques*

2 ANALYSIS

- 2.1 *General*
- 2.2 *Conduct of the flight*
 - 2.2.1 *Runway acceptance by the cockpitcrew*
 - 2.2.2 *The approach*
 - 2.2.3 *The landing*
- 2.3 *The nose landing gear failure*
- 2.4 *The passenger evacuation*
- 2.5 *Runway allocation system versus safety aspects of aircraft operations in crosswind*

3 CONCLUSIONS

4 PROBABLE CAUSE

5 RECOMMENDATIONS

6 APPENDICES

- 1 *Accident Location*
- 2 *Photographs*
- 3 *Reports of Investigations*
 - 3.1 *Boeing DFDR review and calculations of airplane pitch velocity*
 - 3.2 *NLR-CR-98411 Failure analyses of a Boeing 757 NLG wheel well*
 - 3.3 *NLR investigation into windshear*
 - 4 *ATC Transcript*

7 REFERENCES

- i NLR-CR-98388 – Safety aspects of aircraft operations in crosswind
- ii NLR-CR-98527 – Exploratory study on transient effects from autoflight to manual flight during approach and landing under strong crosswind conditions
- iii ADSE-99R 003 – Results FSC simulator test crosswind handling Boeing 757
- iv Geluid Preferentieel Baangebruik Systeem

ABBREVIATIONS

AAIB Air Accident Investigation Branch (UK)

AAS Amsterdam Airport Schiphol

AIIB Accident and Incident Investigation Bureau of the Netherlands Aviation Safety Board

AOM Aircraft Operating Manual

A/P Autopilot

ATC Air Traffic Control

ATIS Automatic Terminal Information Service

ATPL Airline Transport Pilot's Licence

B1 Vliegbewijs voor Verkeersvlieger (=ATPL)

BCMG Becoming

BKN Broken

BR Brume (nevel)

C Celcius

CVR Cockpit Voice Recorder

DFDR Digital Flight Data Recorder

FAR Federal Aviation Regulations

FAS Final Approach Speed

FEW Few

FMS Flight Management System

F/O First Officer

FSC Friendship Simulation Company

ft feet

ft/min feet per minute

g gravity

G Gust

GPBS Geluid Preferentieel Baangebruik Systeem (Runway Allocation System of AAS)

Hpa Hectopascal

HV Transavia

ICAO International Civil Aviation Organization

ILS Instrument Landing System

kg kilogram

kHz kilohertz

KLM Koninklijke Luchtvaart Maatschappij

km kilometer

kt knot

L Left

Lb pound

LDA Landing Distance Available

L.E. Leading Edge

LVB Lucht Verkeers Beveiliging (The Netherlands Air Traffic Control Agency)

MHz Megahertz

NASB Netherlands Aviation Safety Board

NLG Nose Landing Gear

NLR Nationaal Lucht- en Ruimtevaart Laboratorium (Netherlands Aerospace Laboratory)

NLRGC Nationaal Lucht- en Ruimtevaart Geneeskundig Centrum (Aeromedical Institute)

NOSIG No Significant Change

NOTAM Notice to Airmen

NTSB National Transportation Safety Board (USA)

NSW No Significant Weather

OM Outer Marker

OVC Overcast

P.A. Public Address

PF Pilot Flying

P.I.C. Pilot In Command

PNF Pilot Not Flying

QNH Sea level atmospheric pressure

R Right

RA Rain

RLD Rijks Luchtvaart Dienst (Civil Aviation Authority of The Netherlands)

SCT Scattered

SFIM Société de Fabrication d'Instrument de Mesure

SOP Standard Operating Procedure

STA Station

T.E. Trailing Edge

TEMPO Temporarily

UTC Universal Time Coordinated

V Variable

VNV Vereniging van Nederlandse Verkeersvliegers (Dutch Pilots Association)

VOLMET Meteorological information for aircraft in flight

V_{REF} Reference speed

GENERAL INFORMATION OF THE ACCIDENT

Note: All times mentioned in this report are UTC (Local Time minus one hour).

Place	: Amsterdam Airport Schiphol - Runway 19R
Date and Time	: December 24th, 1997, 22:48
Aircraft	: Boeing 757-236, PH-TKC The aircraft sustained severe damage
Operator	: Transavia Airlines
Flight Crew	: Two; no injuries
Cabin Crew	: Six; no injuries
Passengers	: 205; four with minor injuries
Type of Flight	: Passenger Charter Flight
Phase of Flight	: Landing
Type of Accident	: Hard traversing landing – Nosegear collapse

THE INVESTIGATION

The investigation of the accident was performed by the Accident and Incident Investigation Bureau of the Netherlands Aviation Safety Board. Assistance in the investigation was provided by the AAIB of the United Kingdom, the NTSB from the United States of America, Boeing Aircraft Company, the NLR, members of the Aviation Safety Commission of the VNV, KLM and the Operator.

Furthermore a questionnaire has been sent to all passengers. In return 93 completed questionnaires were received. Statements were taken into consideration and where applicable incorporated in the report.

The final determination of the report and the safety recommendations have been made by the Dutch Transport Safety Board. At 1 juli 1999 the Netherlands Aviation Safety Board has been merged into this new multimodal Board.

This transition and its preparations is one of the factors that caused delay in the publication of the report which originally could not be envisaged. Further contributing factors that can be indicated in this connection are understaffing of the Accident and Incident Investigation Bureau of the former Netherlands Aviation Safety Board as well as the long lasting after-effects of the EL AL-Boeing disaster in the Bijlmer.

SYNOPSIS

The crew of the aircraft executed an autopilot coupled ILS approach for runway 19R at Amsterdam Airport Schiphol under strong and gusty windconditions. The autopilot was disconnected at approximately 100 ft in order to make a manual landing. The aircraft touched down hard with its right main landing gear first. When the nose gear touched down hard with the aircraft in a crab angle, the nosegear doghouse broke out of the nosesection and rotated backwards. The collapse of the doghouse resulted in serious damage to the electric/electronic systems and several flight- and engine control cables. The aircraft slid down the runway for approximately 3 km, veered to the right and came to rest in the grass. The passenger evacuation was initiated by the cabin crew and all occupants of the cabin left the aircraft via the escape slides. The cockpit crew evacuated the aircraft via the opened cockpit side windows. A small fire at the left inner brake units was quickly extinguished by the airport fire brigade.

1. FACTUAL INFORMATION

1.1 *History of the Flight*

On December 24th 1997 the Transavia Boeing 757 registration PH-TKC departed Las Palmas airport at 19:03 for the return flight to Amsterdam Airport Schiphol as flight HV 462. On board were two cockpit crew, six cabin crew and 205 passengers. The captain was Pilot Flying (PF) from the left seat.

The flight and the accident were reconstructed using crew statements, the Digital Flight Data Recorder (DFDR), the Cockpit Voice Recorder (CVR) and the recorded wind parameters.

Prior to departure the crew had discussed the weather at Schiphol. The meteorological information was obtained at Las Palmas. The forecast for Schiphol, valid from 16:00 until 01:00, indicated in the second part of the evening a wind of 230° with 26 kt gusts 40 kt, a visibility of more than 10 km, no significant weather, clouds scattered at 1000 ft and broken 2500 ft.

Well before the descent into Schiphol, the crew monitored the weather at Schiphol on the VOLMET and later the ATIS message Delta, reading:

Schiphol Arrival Information Delta: Main landing runway 19R, transition level 045, 220 degrees 30 knots, maximum 40, minimum 19, visibility 10 km, few 1500 feet, broken 2200 feet, temperature 12, dewpoint 10, QNH 1008 Hpa.

The cockpit crew expected turbulence in the approach and requested the purser to have the cabin ready early in the approach.

During the descent the passengers were informed about the expected turbulence in the approach.

At 22:33 the crew received ATIS message Echo, reading:

Schiphol Arrival Information Echo, main landing runway 19R, transition level 45, 220 degrees 31 knots, maximum 41 knots, minimum 21 knots, visibility 10 km, few 2200 feet, scattered 2800 feet, temperature 12, dewpoint 9, QNH 1008Hpa. NOSIG.

The crew performed the approach checklist. V_{REF} was 125 kt and the crew decided to determine the FAS (Final Approach Speed) after a later wind check.

The purser reported “Cabin Ready” at 22:40.

Approach instructed HV 462, to turn over right to locator OA and to start the descent for a landing on runway 19R. The crew reported being established on the ILS on the tower frequency. The tower replied with: “the wind two four zero, three zero, maximum four three knots, cleared to land on 19R”. The crew discussed the wind and apparently had understood the gusts as “fourty” instead of “four three”. The FAS was determined to be 140 kt.

Partial CVR Transcript

UTC	Source		Channel 3 – Captain	Channel 2 - F/O
22:44:33				Tower, hello, Transavia four six two, uh, established ILS on one niner right
22:44:38	TWR	Transavia four six two, hallo, the wind is two four zero, three zero, maxi-mum four three knots, cleared to land on one nine right		
22:44:44				Cleared to land on one niner right, Transavia four six two
22:44:46			Okay	
22:44:47		4 tones 1300 Hz	De wind was...	
22:44:48				Two four zero with, uh, dertig knopen, maximaal veertig
22:44:51			Ja, maar 't gaat om de component hè	
22:44:53			Zeventiende keer veertig..., achtentwintig	
22:44:55			Vijftien knopen d'r bovenop	
22:44:58			Ja?	Ja
22:44:59			(...)	FAS wordt honderdveertig
22:44:50			ja	

The CVR Transcript did not show any discussion about the crosswind. The crosswind component was not calculated.

The captain stated that he expected a positive windshear at lower altitude for which he limited the wind correction factor to establish the FAS to 15 kt.

At around 2.000 ft turbulence started to increase.

Approaching 1.500 ft the landing gear was extended and flaps set at 20. Selected Airspeed was 165 kt. After passing the Outer Marker, flaps were set at 25, followed by 30. Airspeed was selected to 145 kt and subsequently to the FAS of 140 kt.

The landing checklist was completed. The indicated airspeed varied considerably due to the gusty wind.

At 600 ft the captain reported a FMS wind of 240 degrees 50 kt.

According to the DFDR registration, the autopilot align mode started to decrab the aircraft at around 500 ft.

At 22:47:38, just prior to reaching 100 ft, the PF disconnected the autopilot. The auto throttle was inadvertently not disconnected.

At the moment of autopilot disconnect, the aircraft yawed 5° to the right and started to drift to the left. The pilot reacted with control inputs to bring the aircraft back on the required flightpath.

The captain stated that the aircraft also experienced a head-on gust, causing an increase in indicated airspeed as well as in pitch attitude. The PF pushed the nose down and the DFDR showed an engine power reduction, after which the crew recalled experiencing a violent wingdip to the left, followed by one to the right just prior to touch down. The cockpit crew did not perceive the touch down as being hard, neither did the cabin crew. After bouncing of the right main gear, the PF pushed the nose firmly down. This resulted, after touchdown on the left main gear, in a hard and crabbing touchdown of the nose gear. The nose gear construction collapsed at nosewheel touchdown and the aircraft slid down the runway. The damage to the electric/electronic systems caused by the collapsed nose gear doghouse, resulted in extinguishing of the cockpit instrument lighting and in activation of the cabin emergency lighting. Engine controls and flight controls were affected, the autobrake system disconnected and the L.E. and T.E. flaps retracted.

The aircraft drifted to the right side of the runway, where a number of runway edge lights were damaged. The PF managed to bring the aircraft back to the centerline.

The PNF made a mayday call at 22:47:52, as instructed by the PF. After approximately 3.000 m the aircraft veered to the right and departed the runway. When off the runway the main gear bogies sunk into the soft terrain and collided with the top covers of the runway light transformer units. Due to the collision both main landing gears incurred serious damage. Both engines were damaged by ingested concrete debris.

The aircraft came to a stop at a distance of 50 m from the runway edge, having travelled approximately 100 m through the soft terrain. A small fire at the left main gear due to overheated inner brake units, was swiftly extinguished by the airport fire brigade.

When the aircraft came to a stand still, the pilots, after performing the relevant items of the passenger evacuation checklist, eventually evacuated the cockpit via the cockpit side windows. Passengers and cabin crew evacuated via the exit slides. All occupants

evacuated successfully. Three passengers were slightly injured by abrasion and one passenger complained of heart problems.

For further details of the evacuation see para 1.15 Survival aspects.

1.2 *Injuries to Persons*

Injuries	Crew	Passengers	Others	Total
Fatal	0	0	0	0
Serious	0	0	0	0
Minor/None	8	205	0	213
Total	8	205	0	213

1.3 *Damage to Aircraft*

The aircraft was seriously damaged.

1.4 *Other Damage*

Damage was incurred to the runway surface and runway lighting.

1.5 *Personnel Information*

1.5.1 *The Cockpit Crew*

Captain	Netherlands; male; age 53	
Last medical examination:	7-11-1997 at NLRGC Soesterberg. Valid, with the restriction that corrective glasses must be worn.	
Licence:	ATPL (B1) valid until 1-6-1998, with rating for B757	
Last Recurrent training	27-11-1997	
Last Profcheck	17-10-1997	
Flying experience :	All types:	B757
Total	23.197	2.208
Last 12 months	578	411
Last 3 months	157	116
Last 30 days	48	34
First Officer	Netherlands; male; age 34	
Licence:	ATPL (B1) valid until 1-6-1998	
Last medical Examination:	1-5-1997 at NLRGC Soesterberg. Valid without restrictions.	

Last Recurrent training	15-12-1997	
Last Profcheck	16-12-1997	
Flying experience :	All types	B757
Total	3.744	1.074
Last 12 months	607	577
Last 3 months	—	58
Last 30 days	—	18

1.5.2 Cabin Crew

The cabin crew consisted of a Purser and five Cabin Attendants. All Cabin Crew members had a valid recurrent training certificate.

1.6 Aircraft Information

1.6.1. General

Registration	: PH-TKC
Aircraft type	: Boeing B757-236
Manufacturers serial number	: 26635
Date of manufacture	: 11-04-1994
Total aircraft hours / cycles	: 13.629,55 / 4645
Certificate of Airworthiness	: no. 4858, valid until 28-06-1998
Certificate of Registration	: no. 4858 in the name of Transavia Airlines C.V. Westelijke Randweg, 1118 AA Schiphol-Centrum
Engines	: Rolls Royce RB211-535E4-37
Manufacturers serial number	: Engine # 1: 31219 Engine # 2: 31225
Total hours / cycles	: Engine # 1: 13.629,55 / 4645 Engine # 2: 13.629,55 / 4645

1.6.2 Weight and Balance

According to the Load and Trim Sheet made up for the flight from Las Palmas to Amsterdam the Take-off Weight was calculated to be 94.844 kg. The trip fuel was calculated to be 12.898 kg which resulted in an estimated Landing Weight of 81.946 kg. The center of gravity for landing was calculated to be 27.8 % MAC.

The minimum and maximum values were respectively 13.2 % MAC and 33.6 % MAC.

1.6.3 Transavia Operational limitations and Procedures

a. Gross Weights:

Maximum take off weight	:255.500 lb (115.892 kg)
Maximum Landing weight	:210.000 lb (95.254 kg)
Maximum zero fuel weight	:184.000 lb (83.461 kg)

b. Maximum wind components for autoland operations:

Headwind - 25 kt
Crosswind - 15 kt
Tailwind - 15 kt

c. Aircraft crosswind limitations

For the conditions which were present at the time of the accident the maximum crosswind component (including gusts) was >30 kt with the following note:

*“X-wind>...” means that the given component is the maximum **demonstrated** crosswind during aeroplane type certification; this value is formally not limiting; however, actual crosswind-components approaching (or even exceeding) these values should be treated as a strong incentive to divert to a runway with less crosswind.*

d. The Transavia Standard Operating Procedures prescribe disconnection of the autopilot and autothrottle “Not later than 100 ft RA”.

e. The Transavia Non Normal Procedures prescribe the flight crew evacuation duties as follows:

- After shutdown procedures, condition permitting, the co-pilot will leave the aircraft via the forward door on the right hand side as soon as possible. He/she will take control of evacuation outside the aircraft.
- The P.I.C., conditions permitting, will visually check the aircraft for persons left behind and will leave the aircraft via the aft door on the left-hand side. The P.I.C. will then take control of the evacuation.
- If conditions are unfavourable, flight crewmembers will leave the aircraft via the nearest exit (e.g. cockpit side windows).

1.7 Meteorological Information

a. Submitted by the Netherlands Meteorological Institute:

General Situation

A deep depression above Scotland is moving north-eastwards and transports mild and somewhat unstable air with a strong to stormy wind.

Weather situation at Schiphol at approximately 22:48

- wind : on the ground : 230° 33 kt, gusts 46 kt, temperature 12° C
at 500 ft : 240° 45 kt, temperature 10° C
- visibility : 12 km
- weather : dry
- clouds : few Stratocumulus, base 2.200 ft
scattered Stratocumulus, base 2.800 ft
- turbulence : moderate to severe
- 0° C level : 8.000 ft
- icing : nil

b. Forecast presented to the crew at Las Palmas:

The flight folder issued at Las Palmas contained the following forecast for Schiphol:
241448Z 241601 20015KT 6000 BR FEW005 SCT007 BKN009 BCMG 1618
19018G28KT 8000 RA SCT008 BKN012 OVC020 BCMG 1820 19023G35KT 4000
BKN005 OVC008 TEMPO 1822 2000 RA SCT003 BKN004 BCMG 2124
23026G40KT 9999 NSW SCT010 BKN025.

c. Schiphol Actuals:

22:25 23032G45 200V260 9999 FEW022 SCT028 12/09 1008 NOSIG
22:51 23032G42 9999 FEW022 SCT028 11/08 1008 NOSIG

d. ATIS Transmissions:

Arrival Information Delta, issued 242155: Main landing runway 19R, transition level 045, wind 220 degrees 30 knots, maximum 40, minimum 19, visibility 10 km, clouds few 015, Bkn 022, Temperature 12, Dewpoint 10, QNH 1008 HPa.

Arrival Information Echo, issued 242225: Main landing runway 19R, transition level 045, wind 220 degrees 31 knots, maximum 41 knots, minimum 21 knots, visibility 10 km, clouds few 022, scattered 028, temperature 12, dewpoint 9, QNH 1008 HPa, NOSIG.

Arrival Information Echo (modified) issued 242235: Main landing runway 19R, transition level 045, wind 230 degrees 33 knots, variable between 200 and 260 degrees, maximum 45 knots, minimum 22 knots, visibility 10 km, clouds Few 022, Sct 028, temperature 12, dewpoint 8, QNH 1008Hpa, NOSIG. (note: not copied by the crew).

1.8 Aids to Navigation

During the approach HV 462 made use of the Locator OA on frequency 395 kHz and of the ILS runway 19R on frequency 109,500 Mhz. This equipment functioned normally and had no relation with the cause of the accident.

1.9 Communications and Recordings

During the approach and landing at Schiphol, HV 462 maintained contact with Amsterdam Radar on frequency 123,85 MHz, Schiphol Approach on 121,2 MHz and Schiphol Tower on 119,22 MHz. The radio equipment functioned normally and had no relation with the cause of the accident. The transcript of the radiocommunication is attached as Appendix 4.

1.10 Airport Information

Schiphol has several runways which are allocated for take off or landing, based on a Preferential Runway Allocation System. At the time of the accident runway 19R was in use. Runway 19R has a length of 3.300 m, is 45 m wide and has an LDA of 3.300 m. The surface consists of asphalt and was damp. It is equipped with a high intensity approach light system and runway centreline and edge lighting, which functioned normally.

The runway allocation procedure is discussed in paragraph 1.17.1

1.11 Flight Recorders

The aircraft was equipped with a Solid State Digital Flight Data Recorder produced by SFIM, Model F6158 and a Cockpit Voice Recorder of Fairchild, Model A100A.

Both recorders were processed with the assistance of the AAIB, SFIM, the operator and the KLM Flight Safety Department.

The CVR was synchronised with the DFDR, utilising mutual events, in particular the moment of autopilot disconnect. Comparison with the transmissions in the ATC transcript shows the CVR/DFDR time approx. 53 seconds ahead of ATC time. Where a time is mentioned in the text of this report, reference is made to ATC time and a correction of the CVR/DFDR time has been made.

The DFDR stopped at the moment of nose wheel collapse, due to damage to the electronic compartment by the rearward movement of the nose wheel doghouse.

The CVR stopped recording at that same moment, but the recorder continued running for another 5 minutes without recording.

As a result DFDR nor CVR information was available after the moment of nose wheel collapse. An attempt to read the Engine Volatile Memories in order to obtain additional engine information was not successful.

1.12 Description of the Damage

The aircraft sustained severe damage to the nose section, main undercarriage, engines and engine nacelles. In addition, as a result of the collapse of the nosewheel doghouse various engine and flight control cables located behind the nose gear well structure were ruptured. In the same area components of electric/electronic systems were damaged. Refer to the Boeing Field report in Appendix 3.1.

As a result of the damage to the electric/electronic systems, the DFDR and CVR stopped functioning immediately after the moment of nose gear collapse. In addition, cockpit instrument lighting failed and cabin lighting switched over to emergency lighting. The P.A. system and the interphonesystem between front cabin and rear cabin probably failed at nosewheel collapse. This could not be verified due to the additional damage caused during salvation.

1.13 Medical and Pathological Information

Not applicable.

1.14 Fire

Fire occurred at the left main landing gear due to overheated brake units. It was quickly extinguished by the airport fire brigade.

1.15 Survival Aspects

When the aircraft came to a standstill, the cockpit was completely dark and smoke had entered the cockpit. In the dark the pilots performed the shut down procedures by feel. To prevent smoke entering the cabin they decided to keep the cockpit door closed. The captain was unable to find the P.A. handset and when he heard someone at the cockpit door he shouted the order to evacuate. The pilots opened the cockpit side windows which improved the visibility. They eventually, after they assumed that the cabin evacuation was completed because the noise that could be heard behind the closed cockpit door had stopped, evacuated via the side windows.

The evacuation order from the captain had not been heard by the purser. A number of passengers alarmed by the sparks and flames during the roll-out expected a speedy evacuation and a large number of them got up from their seats and started to move towards the exits. Since no evacuation order had been received, the cabin attendants shouted the order to remain seated.

Shortly thereafter the purser initiated the evacuation on her own accord. Due to a failure of the P.A. system between forward and aft cabin, the evacuation order was not received in the aft cabin and exits 3L/R and 4L/R were not opened. Passengers in the aft cabin, seeing forward cabin passengers evacuate, either demanded that their exits should be opened as well or moved forward to evacuate through the forward exits. Eventually all exits were opened.

The two aft slides had to be activated manually. The right aft slide was blown aside and up and assistance from the fire brigade was needed to control the slides. Due to the nose low attitude of the aircraft the aft slides were rather steep and most passengers preferred to evacuate via the forward exits.

A number of passengers reported some panic among the passengers as well as among the cabin crew. The cabin crew stated that although a number of passengers were cle-

arly worried and raised from their seats, in general the passengers followed the instructions correctly and the evacuation could be carried out in an orderly manner.

The captain stated that after he had evacuated the aircraft the fire brigade reported to him that all occupants had evacuated the aircraft.

1.16 Tests and Research

1.16.1 Determination of the landing loads.

The Air Safety Investigation Department of Boeing investigated the loads imposed on the aircraft structure using Digital Flight Data Recorder data. (Appendix 3.1)

It was determined that the aircraft touched down with a sink rate of about 400 ft/min on the right main landing gear (2.1 g), followed by the left main gear (1.5 g). While the right gear bounced, the PF pushed the nose down, causing a pitch down rate of at least 9 degrees per second. The computer simulation showed that the nosegear used all 15 inches of its available stroke and bottomed on its endstop. The nosegear loads in the accident were compared with the design criteria using a kinetic energy calculation approach.

In this calculation only the pitch rate and the nose down elevator command were used. The sinkrate at touchdown and the crabangle were ignored due to the uncertainty of the data. The results were as follows:

	kinetic energy lb-ft	elevator energy lb-ft	total energy lb-ft	ratio to FAR25reqt
FAR Requirement (FAR 25.725)			59.783	1.00
Boeing condition 8 degrees/sec			84.682	1.42
Maximum design energy limit (FAR 25.727)			86.087	1.44
PH- TKC accident 9 degrees/sec	84.537	19.303	103.841	1.74

The energy level associated with the accident exceeded the maximum design energy limit by about 20%.

1.16.2 Failure analysis of a Boeing 757 NLG wheel well.

The NLR conducted an investigation into the breakaway sequence of the nosegear wheel well (Appendix 3.2). Inspection showed that the aft part of the nosegear wheel well (doghouse) was broken loose from the surrounding structure.

The aft doghouse, the bodystation (STA) 324 and 395 bulkhead remnants and fuselage structure adjacent to the fracture were examined in more detail.

The fracture and deformation of STA 324 and 395 bulkheads led to the following breakaway scenario.

The failure started with the buckling of the STA 395 frame, which enabled the aft side

of the aft doghouse to displace in upward direction. The increased load on the STA 324 bulkhead resulted in deformation and fracture. After the aft doghouse separated from the STA 324 bulkhead the aft doghouse rotated aft, thereby bending and twisting the STA 395 frame which ultimately resulted in fracture and complete separation of the aft doghouse.

Macro-examination of the fracture surfaces of the STA 324 and 395 bulkheads showed no indications of pre-existing cracks. Macroscopic features indicated overload as the fracture mechanism.

1.16.3 Investigation into windshear at the time of the accident

The NLR was asked to investigate the possibility of a windshear encounter during the approach of the PH-TKC. (Appendix 3.3).

The actual windvector was calculated using angle of attack, sideslip angle, aircraft pitch- and roll attitude apart from the airspeed, groundspeed, heading and drift. It was shown that despite the high windspeeds, windshear effects were negligible and the turbulence was moderate.

It also appeared that the crosswind component at the time of landing was more than 10 kt higher than could have been derived from the latest wind information received from the tower.

1.16.4 Exploratory study on transient effects from autoflight to manual flight during approach and landing under strong crosswind conditions.

The NLR did an investigation on the transient effects from autoflight to manual flight during approach and landing under strong crosswind conditions (Reference ii).

A limited number of approaches were performed on their research flight simulator focused on the effect of disconnecting the autopilot at low altitude in the "align" mode. It demonstrated a potential control problem which could be alleviated by autopilot disconnect at higher altitude.

In the same report it was stated that FMS wind calculation uses strong filtering resulting in lagged data for the crew. In addition the calculation assumes zero sideslip. Therefore the shown FMS wind may not be as accurate as is generally believed.

1.16.5 Flight simulator test crosswind handling Boeing 757.

On request of the Accident and Incident Investigation Office of the NASB a flight simulator test was conducted with the objective to obtain a qualitative assessment of the handling characteristics of the Boeing 757 during approach and landing in strong crosswind conditions (Reference iii). The moving base Boeing 757 simulator of the FSC at Maastricht-Aachen Airport was used. Eight pilots with 757 or 767 experience participated. The wind conditions during the test corresponded as much as possible with the conditions during the accident. The main results were:

a available time from autopilot disconnect at approx. 100 ft to the landing manoeuvre,

- in the order of 8-9 sec, was too short to get the feel for manual flight. Deviations from the required flightpath were difficult to correct
- b. no unacceptable rudder transients -due to the disconnect of the autopilot in the align mode at the moment of autopilot disconnect at low altitude- have been reported. They were probably obscured in the highly dynamic conditions.
 - c. on the Boeing 757, with the underwing mounted engines, a thrust change immediately results in a pitch change increasing the workload in gusty conditions.
 - d. adverse influence from a still engaged autothrottle after A/P disconnect was hardly noticeable as the autothrottle was overridden when necessary.

1.16.6 Safety aspects of aircraft operations in crosswind.

A NLR study (Reference i) gives a broad overview on safety aspects related to operations in crosswind conditions. Main observations related to the accident are:

- a. a reasonable probability exists that, while wind reports to the pilot indicate that the crosswind is not exceeding 15 kt, in reality the actual encountered crosswind during the landing phase can deviate 10 kt or even more from the reported wind. For higher reported crosswind, deviations may increase accordingly.
- b. accident risk increases exponentially when operating in conditions with crosswind exceeding 20 kt, including gusts.
- c. most crosswind related accidents and incidents are caused by improper or incorrect aircraft control or handling.

1.17 Organizational and Management Information

1.17.1 Runway allocation

To enhance noise abatement in the Amsterdam Airport Schiphol area, Air Traffic Control applies the "noise preferential runway allocation system" ('GPBS': Geluid Preferentieel Baangebruik Systeem). This system is based upon rules, set by amongst others:

- Luchtvaartwet (Aviation Law)
- Wet Luchtverkeer (Air Traffic Law)
- ICAO rules
- Additional AAS runway assignment rules
- Noise abatement rules
- Agreement with surrounding communities, such as Amsterdam

According to LVB regulations nr. SPL 97/199, d.d. 5 november 1997, and AMS 97/351, d.d. 7 november 1997 respectively indicated as "Herziene versie vervoegd nachtregime" (Revision early night regime) and "Wijziging vervoegde instelling nachtregime EHAM" (Amendment early implementation night regime EHAM), the runway allocation system in use at the time of the accident consisted of runway combinations in the following order of preference:

Preference	Landing runway	Take off runway
1	06	01L
2	19R	24
3	06	09
4	27	24
5	01R	01L
6	01L	01L

Runway 09/27: 20.00-22.00 UTC – only if no other runway combination is available
 22.00-06.00 UTC – not allowed, unless circumstances are such that
 otherwise no take-offs or landings can be performed on the airport.

Furthermore the following NOTAM's were valid at the time of the accident:

NOTAM A0622/97:

“REF AIP EHAM AD 2-1-21, 2-1-22.1 DUE TO NOISE ABATEMENT PROC USE OF A
 NON-PREFERENTIAL RWY FOR TKOF/OR LDG NOT PERMITTED. NO RESTRICTIONS
 FOR EMERG OPERATIONS”

NOTAM A0764/97:

“RWY 27: TURBULENCE FORECASTED ON FINAL APPROACH AREA AT WIND
 DIRECTIONS BTN 180 AND 250 DEG AND WINDSPEED MORE THEN 20 KTS.”

NOTAM A0810/97:

“TILL DEC 312359 DUE TO NOISE ABATEMENT PROC LDG RWY 22 AND RWY 24
 WITH APCH OVER THE CITY IS NOT PERMITTED”.

With regard to the windcriteria to be used in runway allocation systems, ICAO recom-
 mended in ICAO “PAN-OPS Doc 8168-OPS/611, 1993 that general crosswind limita-
 tions (15 kt incl gusts) cannot be relaxed without compromising safety unless
 additional measures in wind reporting are taken.

At Schiphol the following windcriteria for runway allocation are used:

Windcriteria

Day and early Nightregime	Dry runway		Wet runway
	Tailwindcomponent ≤ 5 kts		Tailwindcomponent 0 kts
	Crosswindcomponent ≤ 15 kts (incl gusts)		Crosswindcomponent ≤ 10 kts (incl gusts)
Nightregime 22.00 - 0600 UTC	High friction coefficient and CAT I conditions	High friction coefficient and CAT II/III conditions	Low friction coefficient
	Tailwindcomponent ≤ 5 kts	Tailwindcomponent ≤ 5 kts	Tailwindcomponent 0 kts
	Crosswindcomponent ≤ 25 kts (incl gusts)	Crosswindcomponent ≤ 15 kts (incl gusts)	Crosswindcomponent ≤ 5 kts (incl gusts)

Furthermore it is stated in the “Regeling Baangebruik van het LVB-station Schiphol” (Regulations on Runway Application ATC-station Schiphol) that ATC, in order to extend the use of a runway combination with a higher preference, is free to exceed the established criteria when this is aerodynamically acceptable.

In this respect it must be noted that acceptance of an assigned runway is the final responsibility of the pilot-in-command.

1.18 Additional Information

Not applicable

1.19. Useful or Effective Investigation Techniques

Not applicable

2 ANALYSIS

2.1 *General*

No evidence was found to suggest any malfunction of the aircraft or its systems. All airport navigation systems were functioning normally.

During the night the accident took place, the wind at Amsterdam Airport Schiphol was strong and gusty and in relation to the runway in use confronting the crew with a high cross-wind component.

The turbulence level could be classified as moderate. Windshears were not reported. However the existing wind conditions may have included small scale up- and down-drafts and local vortices close to the ground.

The analysis will therefore primarily be focussed on the conduct of the flight in relation to the (cross) wind conditions, followed by an analysis of the nose landing gear failure and the evacuation procedures.

The last part of the analysis will in more general terms focus on the runway allocation system in use on Schiphol Airport versus aircraft operations in crosswind conditions.

2.2 *Conduct of the flight*

2.2.1 *Runway acceptance by the cockpitcrew*

The maximum (demonstrated) crosswind of 30 kt was according the Transavia SOP's not limiting. However additional information mentioned that reaching this value should be a strong incentive to divert to a runway with less crosswind.

During the flight the weather conditions were monitored by the crew. The last ATIS check was done at 22.32 UTC, code Echo, with a wind of 220/31, gusting 41 kt. According to this message the crosswind for runway 19R was well below the demonstrated crosswind component for the aircraft and there was at that time no reason for the cockpit crew not to continue the approach..

Shortly thereafter the ATIS message was amended with the wind 230/33, varying between 200 and 260 degrees, and gusts up to 45 kt. This ATIS message was inadvertently transmitted under the same code as the previous one. Because of the same letter code, ATC as well as the cockpit crew were not alerted that the wind conditions had changed.

During the final approach the crew received a final wind reading from the tower of 240/30 kt maximum 43 kt, resulting in a crosswind of 35 kt. The cockpit crew understood the maximum gust value as "forty" in stead of "four three". The Captain mentally calculated the FAS which was set on 140 kt. The crosswind was not calculated nor discussed.

Given the reported Tower wind and the FMS wind reading at 600 ft (240/50 kt), which were an indication that the crosswind could be expected to be above the demonstrated

crosswind value (30 kt), a go-around should at least have been considered.

In this respect it should be noted that by not establishing a clear and definite crosswind limit in the Transavia Operations Manual a defence barrier against unsafe operations was lost.

Note: After the accident the Operations Manual was amended on instigation of the RLD and a maximum crosswind limit of 30 kt implemented.

2.2.2 The approach

The PF made an automatic approach using the autopilot and the autothrottle system with the intention to disconnect these systems during the last part of the approach to complete the landing manually as the crosswind component exceeded 15 kt, being the maximum value for an automatic landing. Use of the automatic systems has the advantage of an accurately flown flightpath at a selected speed and will also provide the cockpit crew more monitoring and recognition time. However in the Boeing 757 the selection of an automatic approach will also include arming of the autoland function. This results in aircraft alignment starting at approximately 500 ft. The corresponding aileron and rudder control forces are not trimmed. Therefore an autopilot disconnect below 500 ft may initiate destabilisation. When the autopilot is disconnected at a height of 100 ft the pilot has only 8 to 10 seconds to touchdown which gives him, especially in turbulent air, not enough time to observe, evaluate and control a highly dynamic situation.

Two separate simulator experiments were performed to evaluate this problem using the research simulator of the NLR and the Boeing 757 training simulator of FSC Beek.

The experiment of the NLR confirmed the concern of a control problem under adverse weather conditions during the transition from automatic flight to manual flight, thereby creating a potentially dangerous situation close to the ground. During the experiment at FSC Beek the control problem was also demonstrated, although often obscured in the highly dynamic wind conditions.

From both experiments it could however be concluded that at high (cross)windspeeds it is essential to disconnect the autopilot at an altitude which allows for ample time to adapt to the demanding control tasks.

2.2.3 The landing

The autopilot was disconnected slightly above 100 ft. The Autothrottle was inadvertently not disconnected.

Just before touchdown strong disturbances in roll and pitch caused by the gusty wind conditions and the large power changes were compensated by the PF using large control inputs. These conditions and the short time available before landing after autopilot disconnect made it difficult to maintain the required flightpath. The aircraft touched down hard on the right main landing gear in a right rolling motion.

When the right main gear touched down and bounced, the PF immediately pushed the control column forward in an attempt to stop an upwards pitch motion of the aircraft. The left main gear then touched down hard and the nosegear hit the runway with a pitch rate of at least 9 degrees per second and a crabangle of 8 degrees.

The nose gear construction failed immediately.

Due to the collapse of the nosegear construction and the sliding of the front fuselage along the runway, several electrical cables were cut or damaged. As a result cockpit- and instrument lighting systems failed. The Public Address system and Interphone system between front cabin and rear cabin probably failed at nose gear collapse.

Despite the fact that several engine and flight controls were also affected, the PF succeeded in keeping the aircraft on the runway until, at low speed, it left the runway to the right and came to rest in the grass.

2.3 *The nose landing gear failure*

During the landing the nose landing gear construction collapsed almost immediately after its touchdown. Inspection showed that the aft part of the nosegear wheel well (so-called doghouse) was broken loose from the surrounding structure.

Failure analysis carried out by the NLR made clear that:

- a. fracture surfaces of broken parts of the structure showed no indications of pre-existing cracks.
- b. examination of the fracture surfaces indicated overload as the cause of the collapse.

A report received from Boeing Commercial Airplane Group indicated that the energy loading of the nosegear exceeded the maximum design load. For the calculations the pitch rate at touchdown and the nosedown load of the elevator were used. Analysis based on available parameters showed that the maximum certified design energy was exceeded by approximately 20%.

Furthermore the amount of sink rate the nosegear can sustain at ground contact, without causing structural damage, decreases substantially with increasing crab- and roll angle.

2.4 *The passenger evacuation*

The captain stated that when he wanted to initiate the evacuation he could not find the P.A. handset. Instead he shouted the order to evacuate with the door to the cabin closed. The evacuation order was not heard and therefore not acknowledged. Apart from hearing some commotion going on in the cabin, the captain did not positively ascertain that his order was heard and that the evacuation had started. Consequently the evacuation was delayed.

The primary duty for the captain during an evacuation is – conditions permitting – to visually check for persons left behind on board. The primary duty for the co-pilot is to leave the aircraft as soon as possible and take control of the evacuation outside the aircraft, until relieved by the captain.

Both pilots stayed in the cockpit until they assumed that the evacuation was completed and then evacuated via the side windows.

In retrospect it could be argued that the smoke in the cockpit was not a condition preventing the co-pilot to immediately leave the aircraft via the side window.

Also the Captain, after he assumed the evacuation was completed, could at least have checked if the conditions restricted him to visually check the cabin for persons left behind.

In this respect it should be noted that during flight safety training the evacuation duties for the cockpit crew can not be trained simulating real-life conditions.

When the purser initiated the evacuation, the order was not heard in the aft cabin due to the failed P.A. system. This created some confusion and also caused some further delay in the evacuation of the passengers in the aft cabin. A number of passengers reported that the cabin crew was in panic as well. The fact that the cabin attendants were shouting their instructions may have been interpreted as panic. However this shouting is essential and standard procedure for an orderly and expeditious evacuation. It is the opinion of the Board that in view of the circumstances the cabin crew took the right actions.

The steepness of the aft slides due to the position of the aircraft furthermore hampered the evacuation.

The transportation to the terminal and further passenger care took quite some time which caused a lot of frustration and anger among the passengers. These aspects have been further investigated by the Airport Authorities.

2.5 Runway allocation system versus safety aspects of aircraft operations in crosswind

The NLR report on “Safety aspects of aircraft operations in crosswind” states that there exists a reasonable probability that while wind reports to the pilot indicate that the crosswind is not exceeding 15 kt, in reality the actual encountered crosswind during the landing phase can deviate substantially from the crosswind calculated from the reported wind. For a higher reported wind, deviations may increase accordingly. Furthermore the same report states that the accident risk increases exponentially when operating in crosswind conditions exceeding 20 kt, including gusts.

One of the main conclusions therefore is that crosswind operations are in general surrounded with substantial uncertainty, warranting substantial margins to theoretical wind limitations.

The crosswind limitation recommended by ICAO in relation with noise abatement procedures is 15 kt (including gusts).

The GPBS maximum crosswind criterion during night regime is 25 kt (including gusts) which is only marginally below the maximum allowable crosswind component of most aircraft. Furthermore ATC is free to exceed the established GPBS wind criteria, with the aim to extend the use of a runway combination with a higher preference when

this is aerodynamically acceptable.

At the time of the accident runway 24 was used for take-off and runway 19R for landing. This combination was allocated with respect to the night regime and the existing wind conditions. It was based on the 20.38 UTC forecasted wind indicating 230/24, gusting 36. With gusts up to 36 kt runway 27 would have been the preferred landing runway according to the GPBS criteria. However NOTAM A0764/97 and A0765/97 cautioned for turbulence on final 27 with wind directions between 180 and 250 degrees and speeds above 20 kt. Also according to NOTAM's, landings on runway 24 were not allowed at the time the PH-TKC approached Schiphol. The intention of this measure was to minimize inconvenience in noise sensitive areas under the approach to runway 24.

Therefore, according to GPBS criteria, runway 19R became the preferred runway. However based on the 22:35 ATIS and the two min. average wind at 22:43 the crosswind was well above the 25 kt GPBS crosswind criteria.

In conclusion it can be stated that the preferential runway allocation system, especially by excluding Runway 24 for landing, does not reflect the prevailing wind direction at Schiphol thereby creating an increase in cross-wind operations. This together with a cross-wind criterion of up to 25 kt and the freedom to exceed this value makes the present preferential runway allocation system in potential an invitation to unsafe operations.

3 CONCLUSIONS

- 3.1 The cockpitcrew was properly licensed to conduct the flight.
- 3.2 The aircraft had a valid Certificate of Airworthiness and a valid Maintenance Release for the flight.
- 3.3 The weight and centre-of-gravity of the aircraft were within the certified limits.
- 3.4 Before and during the return flight from Las Palmas to Amsterdam the cockpit crew was aware of strong and gusting south-westerly winds at the time of arrival.
- 3.5 The crosswind component, derived from the latest wind information as received by the cockpit crew before starting the approach (Information Echo), was below the GPBS crosswind criteria and the 30 kt demonstrated crosswind component as mentioned in the Transavia Operations Manual.
- 3.6 Because of the same letter code assigned to “Information Echo Modified”, ATC and the cockpit crew were not alerted that the wind conditions had changed.
- 3.7 During the final approach, Schiphol Tower reported the latest wind information which resulted in a crosswind of approximately 35 kt. Based on this information and the FMS wind reading at 600 ft (240/50 kt) a go-around should at least have been considered. As it is the crosswind was not discussed and the crosswind component was not calculated by the cockpit crew.
- 3.8 By not establishing a clear and definite crosswind limit in the Transavia Operations Manual a defence barrier against unsafe operations was lost.
- 3.9 The autopilot was disconnected slightly above 100 feet with the system in the “align” mode. This, given the existing crosswind and the gusty and turbulent weather conditions most probably allowed the PF insufficient time to gain complete control of the aircraft.
- 3.10 The aircraft touched down and bounced hard on the right main landing gear in a right rolling motion, followed by a nosedown input by the PF.
The nose-down rotation caused a hard nose wheel touchdown at a 8 degrees crab angle. The nose gear construction failed as the loads, due to the high negative pitch rate at touchdown and the additional energy from the nosedown elevator position exceeded the maximum certified design energy by at least 20%. The extra loads induced by the crabangle were even not taken into account.
- 3.11 The PF succeeded to keep the aircraft on the runway until at low speed it left the runway to the right.
- 3.12 The response of ATC to the mayday call was immediate and the fire brigade arrived quickly at the accident scene. A fire at the left main wheels was extinguished.

- 3.13 The initiation of the passenger evacuation was delayed because the initial evacuation order was not heard by the cabin crew.
- 3.14 The automatic deployment of the two aft slides failed and had to be activated manually.
- 3.15 High wind speeds and the nose down attitude of the aircraft hampered the evacuation via the aft slides.
- 3.16 There is a reasonable probability that an actually encountered wind during landing deviates from the reported wind. This uncertainty warrants substantial margins to theoretical wind limitations when operating in crosswind.
Note: NLR calculated that the crosswind component at the time of landing was more than 10 kt higher than could have been derived from the latest wind information received from the tower.
- 3.17 The accident risk increases exponentially when operating in crosswind conditions exceeding 20 kts, including gusts.
- 3.18 The crosswind criteria of 25 kt and the freedom to exceed this value, as laid down in the preferential runway allocation system used at Schiphol airport, are in potential an invitation to unsafe operations.

3 CONCLUSIES

- 3.1 De cockpitbemanning beschikte over de juiste Bewijzen van Bevoegdheid om de vlucht uit te voeren.
- 3.2 Het vliegtuig had voor de vlucht een geldig Bewijs van Luchtwaardigheid en een geldig onderhoudsbewijs.
- 3.3 De massa en het zwaartepunt van het vliegtuig waren binnen de toegelaten grenzen.
- 3.4 Voor en tijdens de retourvlucht van Las Palmas naar Amsterdam was de cockpitbemanning op de hoogte van het feit dat er tijdens aankomst een stormachtige zuid-westelijke wind met harde windstoten zou zijn.
- 3.5 De zijwindcomponent, berekend op grond van de laatste windgegevens zoals die voordat met de nadering werd begonnen zijn ontvangen door de cockpitbemanning (Information Echo), was lager dan de zijwindcriteria van het Geluid Preferentieel Baangebruik Systeem (GPBS) en lager dan de gedemonstreerde zijwindlimiet van 30 knopen zoals genoemd in het Transavia-handboek (Operations Manual).
- 3.6 Doordat het bericht (Information Echo Modified) eenzelfde lettercode meekreeg als het daarvoor genoemde bericht werd de Verkeersleiding en de cockpitbemanning niet geattendeerd op de gewijzigde windomstandigheden.
- 3.7 Tijdens de laatste fase van de nadering meldde de verkeersstoren van Schiphol de meest recente windgegevens, hetgeen neerkwam op een zijwind van ongeveer 35 knopen. Op basis van die informatie en de FMS-windindicatie op een hoogte van 600 voet (240/50 knopen), had de beslissing om de landingsprocedure af te breken en een doorstart te initiëren, tenminste moeten worden overwogen. Over de zijwind werd echter niet gesproken en evenmin werd door de cockpitbemanning een zijwindcomponent berekend.
- 3.8 Doordat in het Transavia-handboek (Operations Manual) geen duidelijke en uitdrukkelijke zijwindlimiet was vastgesteld, ontbrak een afweermechanisme tegen onveilig handelen.
- 3.9 De automatische piloot werd op een hoogte van iets meer dan 100 voet ontkoppeld, met het systeem in de "align mode". Daardoor, gegeven de heersende zijwind en de stormachtige weersomstandigheden met veel turbulentie, had de piloot die het vliegtuig bestuurd zeer waarschijnlijk onvoldoende tijd om het toestel volledig onder controle te krijgen.
- 3.10 Het vliegtuig kwam aan de grond en kwam daarbij hard op het rechter hoofd wiel terecht in een naar rechts draaiende beweging, waarna de piloot de neus van het vliegtuig omlaag bracht. Dit laatste leidde ertoe dat het neuswiel hard neerkwam in een 8° "crabangle". De neuswielconstructie brak doordat de hoge negatieve pitchrate bij het neerkomen en de extra energie van de nosedown positie van het hoogteroer, de maximaal toegelaten ontwerpbelasting met tenminste 20% over-

schreed. De extra belasting als gevolg van de schuine stand is hierbij nog niet eens meegenomen.

- 3.11 De bestuurder slaagde erin het vliegtuig op de landingsbaan te houden totdat het bij lage snelheid naar rechts van de baan ging.
- 3.12 De Verkeersleiding reageerde direct op de noodoproep (mayday call) en de brandweer was snel ter plaatse. Een brandje bij de linker hoofdwielen werd geblust.
- 3.13 De evacuatie van de passagiers begon met vertraging doordat de eerste opdracht om te evacueren niet werd gehoord door het cabinepersoneel.
- 3.14 De twee achterste noodglijbanen konden niet automatisch worden uitgezet en moesten handmatig worden geactiveerd.
- 3.15 De evacuatie langs de achterste glijbanen werd bemoeilijkt door de harde wind en door de stand van het vliegtuig met de neus omlaag.
- 3.16 Het is vermoedelijk zeer wel mogelijk dat de werkelijke wind tijdens de landing afwijkt van de wind zoals die wordt gerapporteerd. Deze mogelijke discrepantie betekent dat een aanzienlijke marge ten aanzien van de theoretische windlimieten zou moeten worden genomen indien er sprake is van zijwind.
Opmerking: Het Nationaal Lucht- en Ruimtevaartlaboratorium heeft achteraf berekend dat de zijwindcomponent tijdens de landing meer dan 10 knopen hoger was dan op grond van de laatste windgegevens van de toren kon worden afgeleid.
- 3.17 Het ongevalsrisico neemt exponentieel toe in zijwind condities van meer dan 20 knopen, windstoten inbegrepen.
- 3.18 De criteria voor zijwind van 25 knopen en de vrijheid om die waarde te overschrijden zoals dat is vastgelegd in het Geluid Preferentieel Baangebruik Systeem dat op Schiphol wordt gehanteerd, vormen een potentiële uitnodiging tot onveilige handelingen.

4 PROBABLE CAUSE

The following causal factors were identified:

- i Runway allocation system at Schiphol Airport resulted in strong crosswind conditions for the landing runway in use.
- ii By the omission to state clear and definite crosswind limitations in the Transavia Operations Manual a defence barrier against unsafe operations was lost.
- iii Non calculation and/or discussion of crosswind component resulted in continuing the approach in adverse weather conditions.
- iv Disconnect of the auto pilot in the align mode under the existing wind conditions resulted in an out of trim condition of the aircraft.
- v The low altitude of the auto pilot disconnect in relation to the existing wind conditions allowed the pilot insufficient time to gain complete control of the aircraft which resulted in a hard traversing landing.
- vi The hard nose-wheel touch down exceeding the certified design limits resulted in a failure of the nose gear construction.

4 VERMOEDELIJKE OORZAAK

De volgende oorzakelijke factoren werden vastgesteld:

- i Het baantoewijzingssysteem op Schiphol heeft geleid tot sterke zijwindomstandigheden voor de gebruikte landingsbaan;
- ii Door het niet opnemen van een duidelijke en uitdrukkelijke zijwindlimiet in het Transavia-handboek (Operations Manual) werd niet beschikt over een beschermingsmiddel tegen onveilig handelen;
- iii Het niet berekenen en/of bespreken van een zijwindcomponent heeft geleid tot het doorzetten van de nadering in ongunstige weersomstandigheden;
- iv Het ontkoppelen van de automatische piloot in de “align mode” leidde onder de heersende windomstandigheden tot een “out of trim” conditie van het toestel;
- v Door de geringe hoogte waarop de automatische piloot werd ontkoppeld in combinatie met de heersende windomstandigheden, had de piloot onvoldoende tijd om het toestel volledig onder controle te krijgen, hetgeen resulteerde in een harde landing waarbij het toestel bovendien traverserend op de baan kwam.
- vi Het hard neerkomen van het neuswiel waarbij de belasting de toegelaten ontwerp-limieten overschreed, leidde tot het falen van de neuswielconstructie.

5 RECOMMENDATIONS

Introduction

The Board notes that the consequences of the accident could have been far worse. The study identified the fact that the plane landed in a strong crosswind as one of the main causes of the accident. On the basis of the wind data available to the control tower, a crosswind component of 35 knots was calculated at the start of the investigation. Later, however, the National Aerospace Laboratory (NLR) determined that in reality it may have been 10 knots higher.

Most aircraft accidents occur during take-off and landing, with landing entailing the most risks. 'Statistics over the last ten years show that the major risk is during approach and landing. This is when 50% of all aircraft accidents occur.'¹ As far as other causal factors are concerned, wind is a circumstantial factor in one out of three accidents.² The combination of landing and weather conditions (a strong crosswind) therefore warrants closer attention. Various studies have pointed to the risks associated with this combination. For instance, an NLR study states that although the risk of accidents is very low, it increases sharply with a crosswind of 20 knots or more.

Aircraft manufacturers give limits for the maximum crosswind for each type of aircraft. They include a limit based on tests, the demonstrated crosswind, and a limit based on simulations, the manufacturer's limit. In the case of the Boeing 757, the manufacturer's limit is a crosswind of 40 knots (at an angle of 90° to the flight direction) and the demonstrated crosswind limit is, without gusts, 30 knots (also at 90°). The latter limit is generally adopted by aircraft users. In the case of Transavia, a note was included in the pilots' manual, though a great deal was left to the judgement of the pilots themselves:

"X-wind (crosswind) > ..." means that the given component is the maximum demonstrated crosswind during aeroplane type certification; this value is formally not limiting; however actual crosswind-components approaching (or even exceeding) these values should be treated as a strong incentive to divert to a runway with less crosswind.'

After the accident, the Transavia manual was amended in this respect, and a crosswind limit of 30 knots is now specified.

A complicating factor is the increasing use of runway allocation systems. Certain runways may be closed for environmental reasons, especially in connection with noise nuisance, which increases the chance of having to land with a crosswind. For this reason, the International Civil Aviation Organisation (ICAO), of which nearly all countries are members, has advised its members to regulate runway usage so as to ensure that the crosswind component does not exceed 15 knots.

¹ Stuart Matthews, president of the Flight Safety Foundation, USA, at the Second World Congress on Transport Safety, 18-20 February 1998, Delft.

² Flight Safety Foundation Proceedings, March 1999.

Since wind speed measuring systems are not always accurate³, and the wind speed (and direction) may be constantly changing, the limit of 15 knots represents an in-built safety margin and can prevent the demonstrated crosswind limit being exceeded. If the airport has only one runway, then obviously no allocation can take place and the demonstrated crosswind limit specified by the manufacturer should be used. If it is impossible to land within the stipulated limits, the aircraft will have to be diverted to another airfield.

In practice, there seems to be a tendency to allow aircraft to land in a strong crosswind despite the attendant risks. Diverting aircraft to another airfield which has a runway with a less strong wind or with a more favourable orientation in relation to the wind, e.g. head-on, is generally felt to be very inconvenient by all concerned, including passengers, crew and airlines; passengers are not at their destination and miss their connections, no replacement crew is available, technical inspection of the aircraft cannot be carried out, etc.

In the case in question, the Transavia aircraft was allocated runway 19R by traffic control. The available wind data initially fell within the demonstrated limits, but the situation changed just before the landing. In these weather conditions that existed at Schiphol, runway 24 would have been the most suitable in terms of flight safety. Under the runway allocation system, this runway is not used for landing purposes at night because the approach route passes over Amsterdam and causes noise nuisance. Exceptions are only made in an emergency.

For the landing to comply with the permissible crosswind limits, it would be necessary to divert the aircraft to an airfield having a runway with the same orientation as runway 24. This would have meant landing at Rotterdam or Brussels, for example. Since nobody is in favour of this, and since landings with a strong and/or increasing crosswind entail risks, the question arises as to whether in such weather conditions (which are not unusual in the Netherlands) – namely, a strong southwesterly wind of 20 to 25 knots and good visibility – it should be possible to use runway 24. The case is strengthened by the fact that wind measurements are not always reliable and the wind direction and strength can suddenly change at the last moment. It is also possible for the limits to be suddenly exceeded, as happened in the present case. In view of the uncertainties surrounding the measured strength of the crosswind and the elevated risk presented by landing in a crosswind, the Transport Safety Board believes that the runway allocation system (GPBS) should adhere to the ICAO's recommended crosswind limit of 15 knots. The question of the use of runway 24 needs to be raised in this connection.

The fact that the pilot switched from automatic pilot to manual, and above all the altitude at which this took place, played a role in the accident. The manuals only specify a minimum altitude of 100 feet (approx. 30 metres), which proved to be too low in the prevailing weather conditions. The Transport Safety Board takes the view that airline companies should include a caution in the manuals on the minimum altitude at which the automatic pilot must be switched off in poor weather conditions.

³ Because the measurements are made at locations other than the relevant landing zone, the measured wind speed may differ from the actual speed at the runway in question.

Finally, the evacuation of passengers deserves a brief mention. In addition to the aspects referred to in the recommendations, the Board would like to designate this issue in its entirety as a matter requiring further attention in the future. It should be noted that a number of international studies are being conducted on this matter, e.g. by ICAO, which may provide a good starting point in due course.

Recommendations

To the Netherlands Air Traffic Control Agency:

- 5.1 In addition to the wind information for landing ATC should provide pilots with the actual tail- and cross-wind component.

To Operators:

- 5.2 During training pilots should be made aware of the uncertainty with regard to wind speed in the reported wind information;
 - 5.2.1 Operator Operations Manuals should contain a “CAUTION” with regard to the minimum height for autopilot disconnect in adverse wind conditions especially in relation to the “align” mode;

To the Minister of Transport and Public Works:

- 5.3 The preferential runway allocation system in use at Amsterdam Airport Schiphol should be reviewed with respect to:
 - recommended ICAO limitations;
 - uncertainty of present wind information;
 - potential risks of operating in (strong) crosswind conditions;
 - freedom by ATC to exceed the established GPBS criteria.

To Operators:

- 5.4 Operators should review passenger evacuation procedures with respect to:
 - (partial) failure of interphone and or public address systems;
 - use of slides under high wind speeds;
 - further elaboration of the cockpit crew evacuation duties during actual flight safety training;

5 AANBEVELINGEN

Inleiding

De Raad merkt op dat het ongeval uiteindelijk een relatief goede afloop heeft gehad.

De consequenties hadden aanzienlijk ernstiger kunnen zijn.

Bij de oorzaken, zoals die uit het onderzoek naar voren zijn gekomen, is de landing met een sterke zijwind als belangrijke factor geïdentificeerd. Aan de hand van de windgegevens, die beschikbaar waren op de toren, is in de beginfase van het onderzoek een zijwindcomponent van 35 knopen berekend. In een later stadium heeft het Nationaal Lucht- en Ruimtevaartlaboratorium (NLR) vastgesteld dat dit in werkelijkheid nog wel eens 10 knopen hoger kan zijn geweest.

Indien wordt gekeken naar de fase van de vlucht waarin ongevallen geschieden dan blijkt het merendeel van de ongevallen zich af te spelen in de fase van de start en van de landing. De fase van de landing brengt daarbij de meeste risico's met zich mee.

“Statistics over the last ten years show that the major risk is during approach and landing. This is when 50% of all aircraft accidents occur”¹.

Als wordt gekeken naar factoren die ongevallen (mede) veroorzaken, dan is wind bij één op de drie ongevallen een bijdragende factor².

De combinatie van landing en weersomstandigheden waarbij sprake is van sterke zijwind, verdient derhalve nadere aandacht. In verschillende studies is ook al gewezen op de risico's die aan deze combinatie zijn verbonden. Zo vermeldt een studie van het NLR uitdrukkelijk dat de weliswaar zeer geringe kans op ongevallen vanaf 20 knopen zijwind sterk gaat toenemen.

De fabrikanten van vliegtuigen geven voor elk type vliegtuig een limiet voor de maximale zijwind. Dat is enerzijds een in werkelijkheid geteste limiet, de gedemonstreerde zijwind en een aan de hand van simulatiemodellen berekende limiet, de fabriekslimiet. Bij de Boeing 757 bedraagt de fabriekslimiet 40 knopen zijwind (in een hoek van 90° op de vliegrichting) en is de werkelijk gedemonstreerde zijwindlimiet, zonder windstoten, 30 knopen (eveneens op 90°).

Deze laatste (gedemonstreerde) limiet wordt in het algemeen ook als limiet aangehouden door de gebruikers van de vliegtuigen. In het geval van Transavia was er wel een vermelding opgenomen in het handboek voor de vliegers, er werd echter veel aan het inzicht van de vliegers zelf overgelaten:

“X-wind (crosswind)>...” means that the given component is the maximum demonstrated crosswind during aeroplane type certification; this value is formally not limiting; however actual crosswind-components approaching (or even exceeding) these values should be treated as a strong incentive to divert to a runway with less crosswind.

¹ Stuart Matthews, president Flight Safety Foundation, USA, op het Tweede Wereldcongres Transportveiligheid, 18-20 februari 1998, Delft.

² Flight Safety Foundation Proceedings, maart 1999.

Na het ongeval zijn de teksten in het handboek van Transavia in dit opzicht gewijzigd en wordt nu uitdrukkelijk een zijwindlimiet van 30 knopen vermeld.

Een complicerende factor bij dit alles wordt gevormd door het gegeven dat steeds meer wordt overgegaan op baantoewijzingssystemen waarbij om milieuredenen, met name geluidshinder, bepaalde banen kunnen worden gesloten. Dat heeft tot gevolg dat de kans op landingen met zijwind toeneemt. Om deze reden heeft de International Civil Aviation Organisation (ICAO), een overkoepelende organisatie waarbij vrijwel alle landen zijn aangesloten, een aanbeveling voor zijn leden opgesteld om het baangebruik dan zo te regelen dat de zijwindcomponent niet boven de 15 knopen uitkomt.

Aangezien de meetsystemen voor de windsnelheid niet altijd nauwkeurig zijn³ en die windsnelheid (en richting) ook voortdurend aan verandering onderhevig kan zijn, is in feite met de limiet van 15 knopen een veiligheidsreserve ingebouwd en kan worden voorkomen dat de gedemonstreerde zijwindlimiet wordt overschreden. Indien het vliegveld slechts één baan heeft, kan er uiteraard geen sprake zijn van een toewijzingssysteem en wordt de door de fabrikant aangegeven gedemonstreerde zijwindlimiet gehanteerd. Als er niet binnen de gestelde limieten kan worden geland, zal naar een ander vliegveld moeten worden uitgeweken.

In de praktijk lijkt er een neiging te bestaan dat ondanks het risico dat kleeft aan landingen met sterke zijwind, dit toch te accepteren. Het moeten uitwijken naar een ander vliegveld met een landingsbaan waar een minder sterke wind staat of waar de ligging ten opzichte van de wind gunstiger is, bijvoorbeeld recht op de neus, wordt door alle betrokkenen, passagiers, bemanning en maatschappijen, veelal als uiterst onaangenaam ervaren. Passagiers zijn niet op hun bestemming, missen hun doorverbindingen, vervangende bemanning is niet direct voorhanden, geplande technische controle van het vliegtuig kan niet worden uitgevoerd, etc.

Het vliegtuig van Transavia kreeg in dit geval van de verkeersleiding baan 19R toegewezen. In eerste instantie vielen de beschikbare windgegevens binnen de gedemonstreerde limieten. Vlak voor de landing veranderde deze situatie.

Bij de toen geldende weersomstandigheden op Schiphol zou qua vliegveiligheid baan 24 de meest gunstige zijn geweest. Op grond van het baantoewijzingssysteem mocht deze baan, vanwege de aanvliegroute over Amsterdam en de daarmee gepaard gaande geluidshinder, 's nachts niet worden gebruikt als landingsbaan. Hierop wordt alleen een uitzondering gemaakt indien er sprake is van een noodsituatie.

Voor een landing binnen de toegestane zijwindlimieten zou er moeten worden uitgeweken naar een vliegveld waar wel kan worden beschikt over een baan met dezelfde ligging als baan 24. Dat zou hier betekend hebben, uitwijken naar bijvoorbeeld Rotterdam of Brussel.

Gelet op het gegeven dat uitwijken door niemand wordt geprefereerd en gelet op het gegeven dat landingen met een sterke en/of toenemende zijwind risico's met zich brengen, doet zich de vraag voor of bij dit soort in Nederland niet ongebruikelijke weersomstandigheden, een sterke zuid-westelijke wind van 20 tot 25 knopen en bij goed zicht, baan 24 niet zou moeten worden opengesteld. Dit wordt nog versterkt door de ervaring dat windmetingen niet altijd betrouwbaar zijn en bovendien de windrichting en -kracht

³ Doordat de meting op andere locaties geschiedt dan in de betrokken landingszone, kan de gemeten windsnelheid afwijken van de werkelijke snelheid op die bepaalde baan.

op het laatste moment plotseling kunnen veranderen. Het kan dan gebeuren, zoals ook in dit geval, dat de limieten toch ineens worden overschreden. Gezien de eerder genoemde onzekerheden met betrekking tot de (meting van de) sterkte van de zijwind en de toename van het risico van landingen met zijwind, is de Raad voor de Transportveiligheid van mening dat het baantoewijzingssysteem (het Geluid Preferentieel Baangebruik Systeem, GPBS) uitdrukkelijk in overeenstemming dient te zijn met de aanbeveling van ICAO (zijwindlimiet van 15 knopen). Daarbij zou ook de hiervoor gestelde vraag met betrekking tot het gebruik van baan 24 aan de orde moeten worden gesteld.

Bij het ongeval heeft ook het overschakelen van de automatische piloot naar handbediening en dan met name de hoogte waarop dat is geschied, een rol gespeeld. In de handboeken is thans alleen sprake van een minimumhoogte van 100 voet (zo'n 30 meter), hetgeen onder de gegeven weersomstandigheden te laag bleek te zijn. Naar de mening van de Raad voor de Transportveiligheid zouden de luchtvaartmaatschappijen in de handboeken een waarschuwing ("caution") moeten opnemen over de minimumhoogte waarop de automatische piloot moet worden uitgeschakeld bij ongunstige windomstandigheden.

Tot slot nog een enkele opmerking met betrekking tot de evacuatie van passagiers. Naast de aspecten die bij de aanbevelingen worden genoemd, zou de Raad dit onderwerp in zijn algemeenheid als een aandachtspunt voor de toekomst willen kenschetsen. Er kan op worden gewezen dat hierover enkele internationale studies gaande zijn, onder andere in ICAO-verband, die daarvoor te zijner tijd goede aanknopingspunten kunnen bieden.

Aanbevelingen

Aan de Lucht Verkeers Beveiliging Nederland:

- 5.1 Aanvullend op de voor de landing te verschaffen informatie over de wind, dient de Verkeersleiding de piloten te informeren over de feitelijke staartwind en zijwindcomponent.

Aan de luchtvaartmaatschappijen:

- 5.2 Piloten dienen in hun opleiding bewust te worden gemaakt van de onzekerheden ten aanzien van de windsnelheid in de informatie over wind die hen wordt gerapporteerd.
 - 5.2.1 De handboeken van operators dienen een waarschuwing te bevatten met betrekking tot de minimum hoogte voor de ontkoppeling van de automatische piloot bij ongunstige windomstandigheden met name in relatie tot de "align" mode.

Aan de Minister van Verkeer en Waterstaat:

- 5.3 Het Geluid Preferentieel Baangebruik Systeem (GPBS) dat op Schiphol wordt gebruikt, dient te worden herzien ten aanzien van de

- aanbevolen ICAO beperkingen
- onbetrouwbaarheid van de huidige windinformatie
- potentiële risico's van vliegen in (sterke) zijwindomstandigheden
- vrijheid van de Verkeersleiding om de vastgestelde GPBS criteria te overschrijden.

Aan de luchtvaartmaatschappijen:

- 5.4 De procedures die door operators worden gehanteerd voor de evacuatie van passagiers dienen te worden herzien met betrekking tot:
- (gedeeltelijk) niet functioneren van de spraakverbindingen met het cabinepersoneel en de passagierscabine
 - gebruik van de noodglijbaan bij hoge windsnelheden
 - verdere uitwerking van de taken van de cockpitbemanning bij de veiligheidstrainingen.

REPORT 97-75/A-26

APPENDIX 1

ACCIDENT LOCATION

ACCIDENT LOCATION



PHOTOGRAPH COURTESY AIRPOLICE

REPORT 97-75/A-26

APPENDIX 2

PHOTOGRAPHS



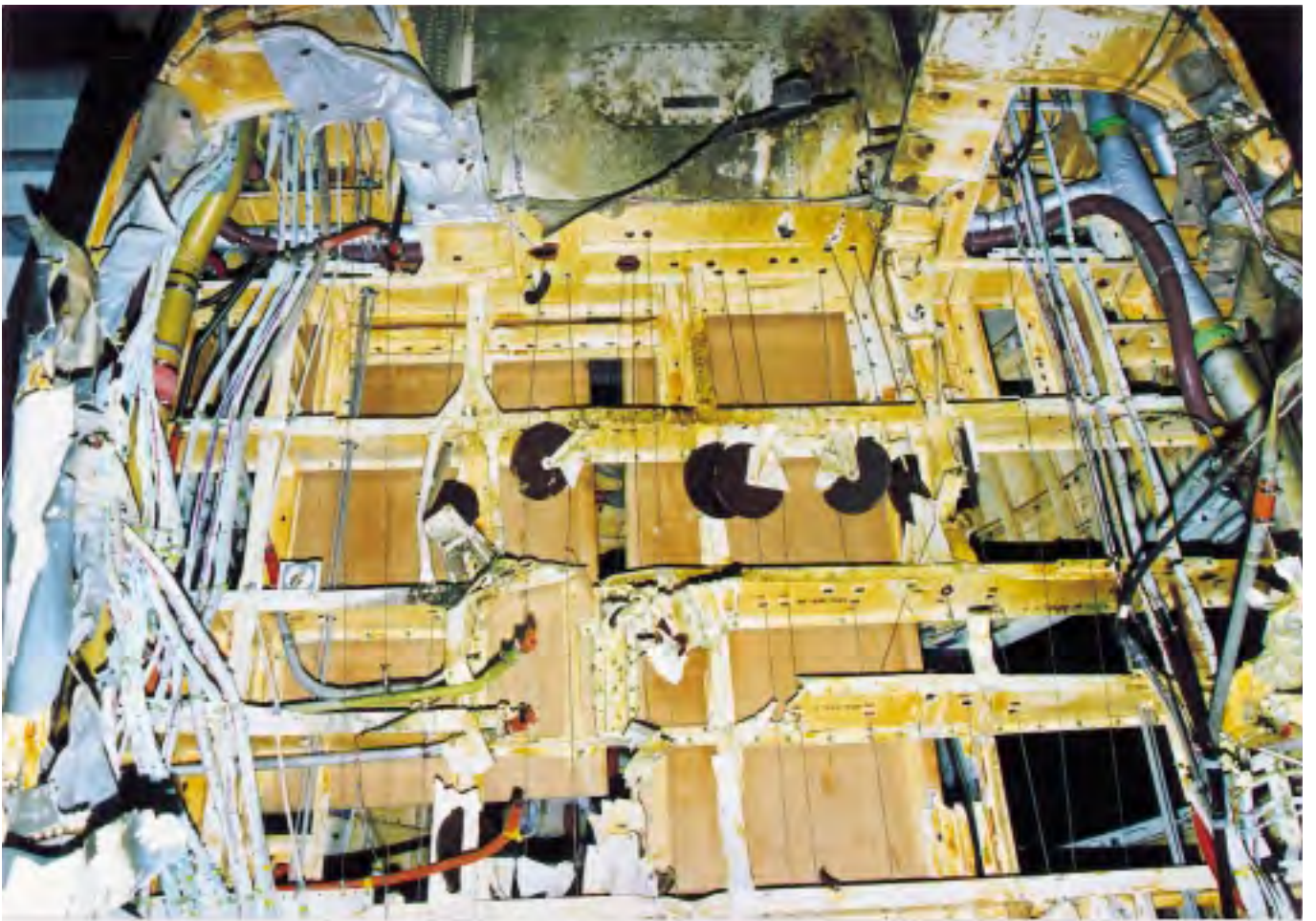

DAMAGE TO CONTROL CABLES

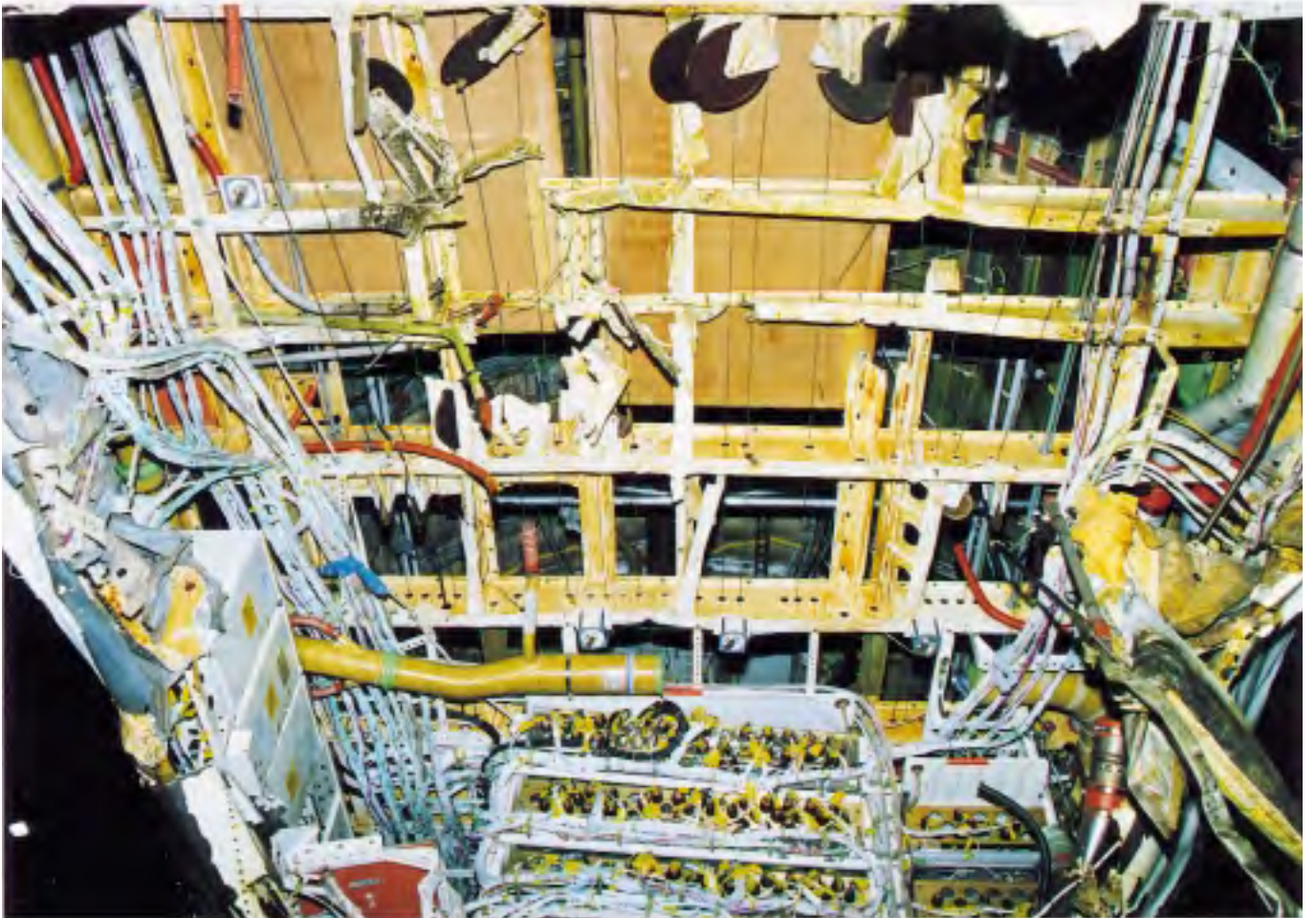

DAMAGE TO ELECTRONIC COMPARTMENT

REPORT 97-75/A-26

APPENDIX 3.1

Boeing DFDR review and calculations of airplane pitch velocity

10 December 1998
B-B600-16569-ASI

Mr. B. A. Groenendijk
Director of Investigations
Netherlands Aviation Safety Board
Barentz gebouw
Saturnusstraat 5
2132 HB Hoofddorp
The Netherlands
Fax: 31-70-333-7077
Phone: 23-333-7000



By Facsimile

Subject: TAV 757-200 PK-TKC/NB453 Landing Accident at Amsterdam on
24 Dec 1997

Reference: (a) Your Fax to John Purvis, Dated 2 December 1998
(b) Boeing Letter B-B600-16506-ASI, Dated 26 August 1998

Dear Mr. Groenendijk:

The following information is provided in response to your reference (a) fax which requested a discussion of our DFDR review, and our calculations of airplane pitch velocity and nose gear loads that were discussed in our reference (b) letter.

The majority of the DFDR data has rather slow sample rate of once per second and since the data recording stopped shortly after touchdown, the recorded data does not provide enough information to accurately describe the event. The peak values were not necessarily captured in the data either. The attached Figures 1 to 6 contain plots of the pertinent DFDR data for our analysis, Figures 1 and 2 have speed and directional data, Figures 3 and 4 have roll data and Figures 5 and 6 have vertical data. Figures 1, 3, and 5 have the last 35 seconds of DFDR data while Figures 2, 4, and 6 have the last 6 seconds of data (flare and touchdown).

The airplane encountered a strong cross wind during landing. The drift angle varied between -4 to -10 degrees during final approach and was at about -5 degrees at time of touchdown as shown in Figures 1 and 2.



From Figures 3 and 4, the pilot was very busy responding to the cross wind to keep the airplane level. During the flare, beginning about time 398, the pilot had a few rapid maximum wheel cycle commands to fight the progressively bigger roll response of the airplane.

From Figure 5, it appears the pilot had a hard time keeping the airplane in constant pitch angle during approach too. From Figure 6, the sink rate at touchdown was higher than normal at 13 foot per second, exceeding the 10 foot per second design limit. The airplane landed on the right main landing gear (RMLG) and had a recorded 2.1 g's (the actual peak may be higher) hard landing, it then bounced off the RMLG and landed on the left main landing gear (LMLG) at 1.5 g's (or higher). While bouncing off the RMLG, the pilot pushed down the control column to command pitch down elevator within 1 second of RMLG touchdown. The pitch rate at nose gear contact was estimated to be at least 9 degrees per second from the pitch angle on Figure 6.

The amount of sink rate the nose gear could handle at ground contact without sustaining structural damage decreases substantially with increasing crab angle and roll angle.

In Figure 7 we have plotted airplane pitch, airplane altitude, elevator position, control column, vertical acceleration and main landing gear bogie tilt versus time following initial touchdown. These parameters were taken directly from the DFDR data. The actual data points are shown by symbols. The airplane pitch time history plot was spline curve fitted and its derivative was plotted as pitch rate. The last data point has a pitch rate of approximately 9 degrees per second. The nose landing gear ground contact occurred shortly after the last data point was recorded. The spline curve fit was also applied to the altitude time history data and its derivative was plotted as sink rate. The last data point has a sink rate of about 6 feet per second.

Figure 8 shows time history plots of a dynamic simulation. Since this simulation used a symmetric model only, the goal of this simulation was to simulate nose landing gear response. A simulated elevator command was applied to make the pitch rate at nose landing gear ground contact to be 9 degrees per second. An airplane sink rate of 2 feet per second was used to make it easier to achieve the desired pitch rate at nose landing gear ground contact. Our computer simulation disclosed that the nose landing gear used up all 15 inches of its available stroke and reached a high bottom out load of 130 kips.

The last three pages compares the TAV 757-200 PH-TKC/NB453 accident nose landing gear with the 757-200 nose landing gear design criteria using an energy approach. The data compares the amount of energy to be absorbed for the FAR 25.725 ten feet per second drop test, the FAR 25.727 twelve feet per

second reserved energy drop test and the Boeing eight degrees per second pitch rate condition, against the estimated energy absorption from the PH-TKC/NB453 accident. The kinetic energy from the accident was estimated by using the energy associated with the pitch angular momentum of the airplane only, the energy associated with the sink rate was ignored due to uncertainty of the data. The kinetic energy was then combined with the estimated energy input following initial nose gear contact from the elevator command. This combined energy is the total energy needed to be absorbed by the nose landing gear. The maximum design energy of the 757-200 nose landing gear is approximately 86,000 lb-ft. The energy level associated with the accident exceeded this by about 20%.

If you have any questions, please do not hesitate to call.

Very truly yours,



Ronald J. Hinderberger
Director, Air Safety Investigation
Org. B-B600, M/S 67-PR
Phone (425) 237-8525
Fax (425) 237-8188

Enclosures: As noted in text (11 pages)

cc: R. Benzon, NTSB, AS-10 (with enclosures)



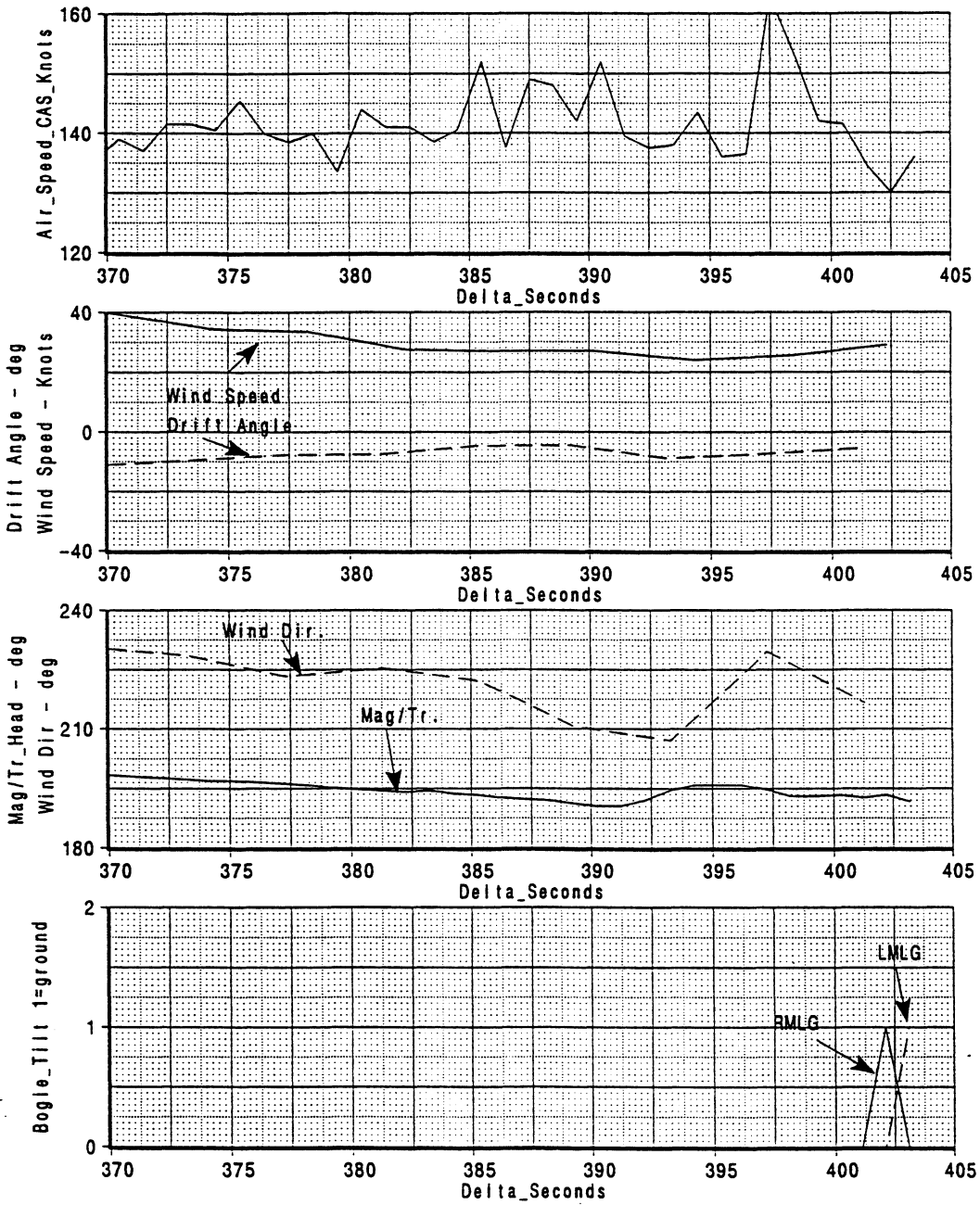

[A]: /acct/ccm1207/taac/tkc24127.esb

Thu Jul 30 1998 08:42:44

CALC	C. C. Ma	30Jul98	REVISED	DATE	TAV 757-200 PK-TKC/NB453 Landing Accident DFDR, Directional Parameters	757-200
CHECK						
APPD.						
APPD.						
					BOEING	PAGE Figure 1

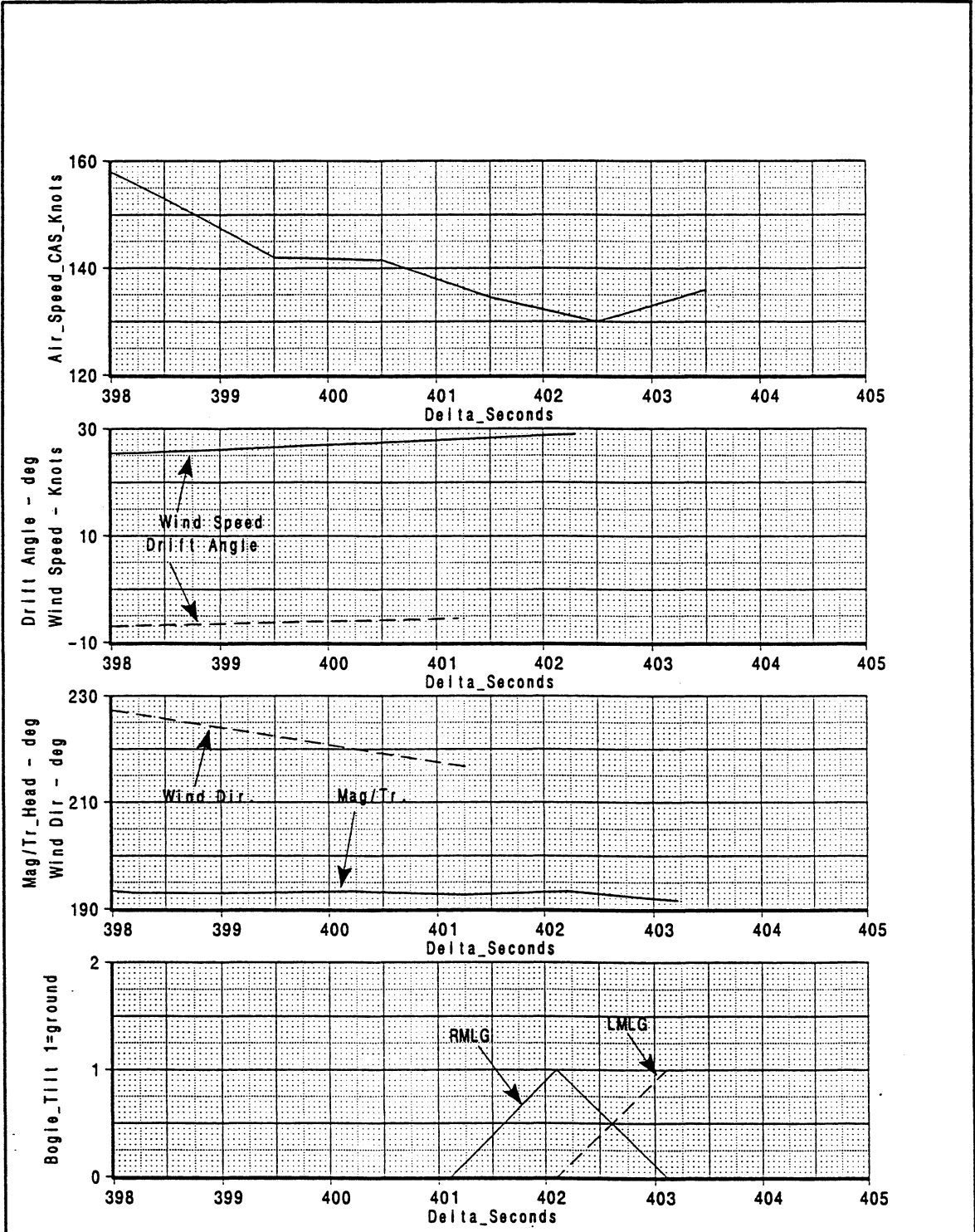

[A]: /acct/ccm1207/taac/tkc24127.esb

Thu Jul 30 1998 08:43:17

CALC	C. C. Ma	30Jul98	REVISED	DATE	TAV 757-200 PK-TKC/NB453 Landing Accident	757-200
CHECK					DFDR, Directional Parameters	
APPD.					Flare, Touchdown	
APPD.					BOEING	PAGE Figure 2

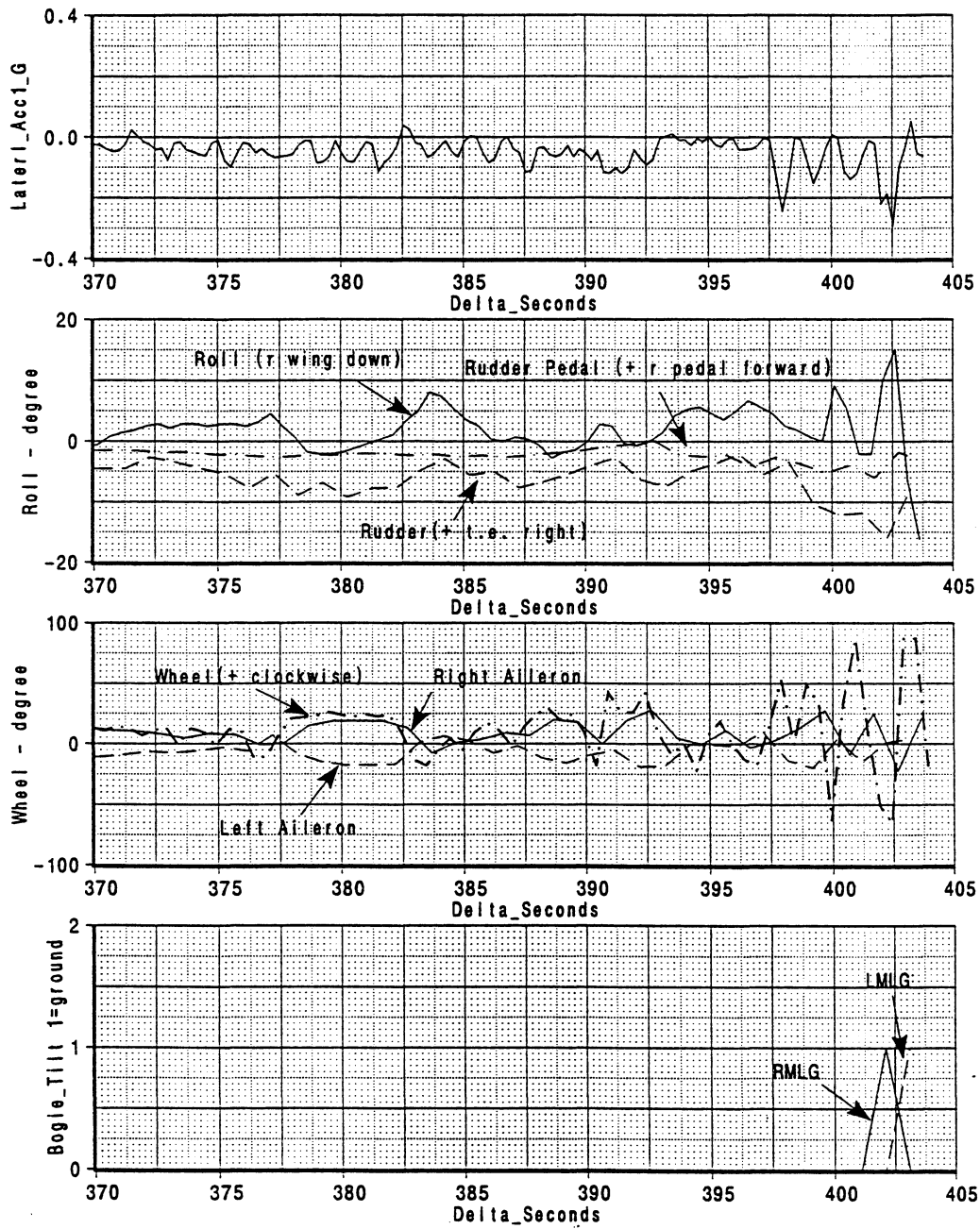

[A]: /acct/ccm1207/taac/tkc24127.esb

Fri Aug 7 1998 08:05:40

CALC	C. C. Ma	7Aug98	REVISED	DATE	TAV 757-200 PK-TKC/NB453 Landing Accident	757-200
CHECK					DFRD, Roll parameters	
APPD.					BOEING	PAGE
APPD.						Figure 3

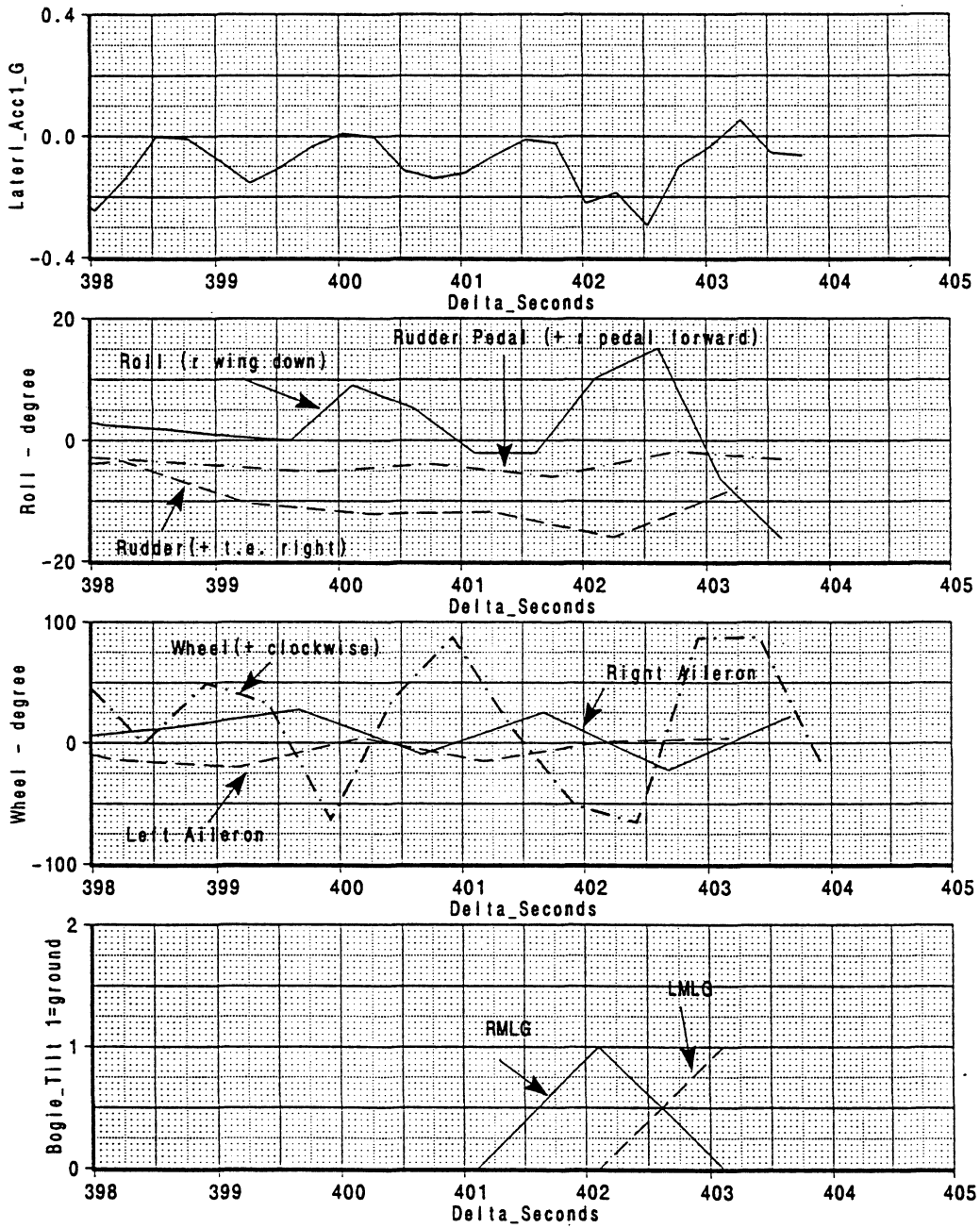

[A]: /acct/ccm1207/taac/tkc24127.esb

Fri Aug 7 1998 08:02:00

CALC	C. C. Ma	7Aug98	REVISED	DATE	TAV 757-200 PK-TKC/NB453 Landing Accident	757-200
CHECK					DFRD, Roll parameters	
APPD.					Flare, Touchdown	
APPD.					BOEING	PAGE Figure 4

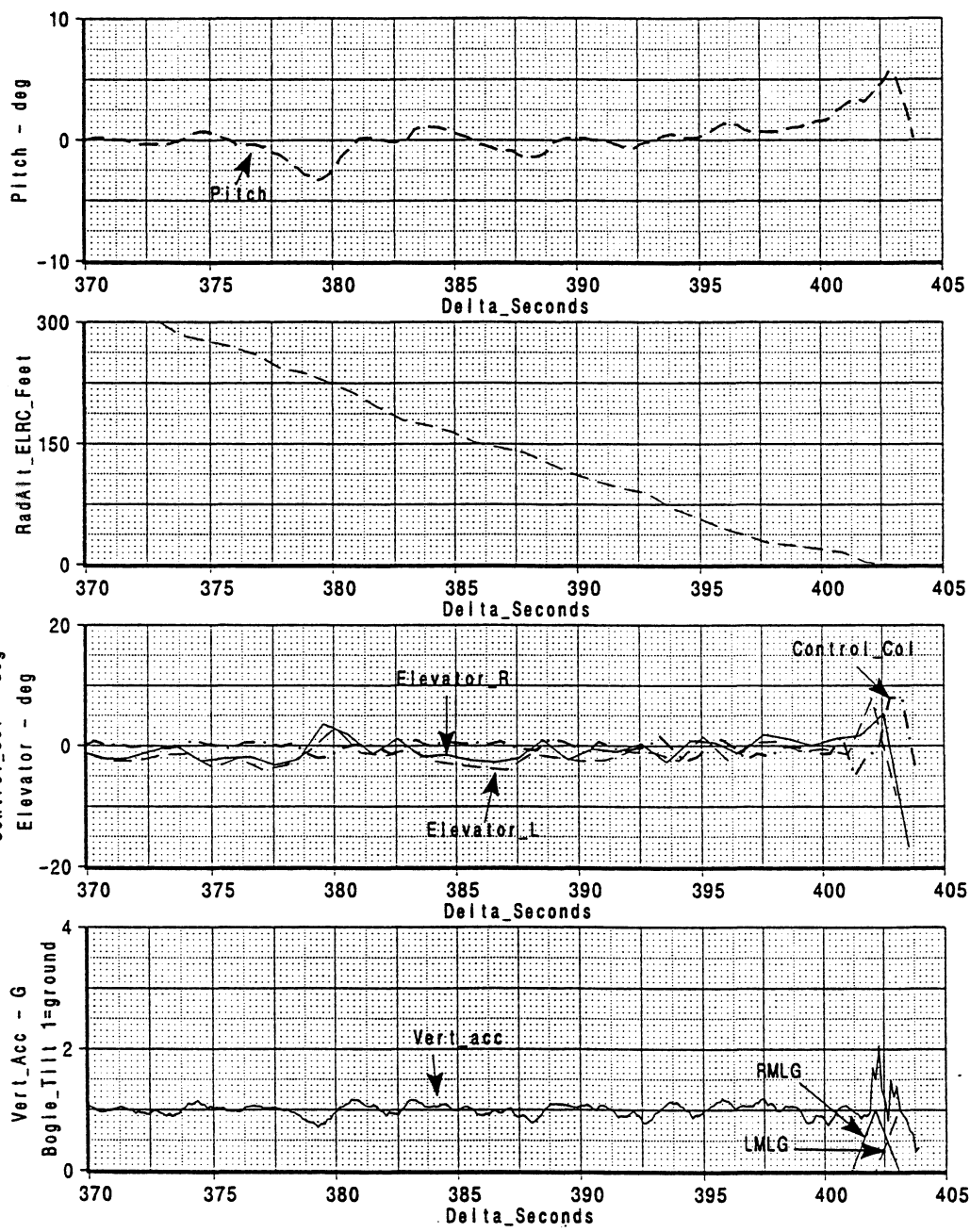

[A]: /acct/ccm1207/taac/tkc24127.esb

Thu Jul 30 1998 08:45:18

CALC	C. C. Ma	30Jul98	REVISED	DATE	TAV 757-200 PK-TKC/NB453 Landing Accident DFDR, Vertical parameters	757-200
CHECK						
APPD.						
APPD.						
BOEING						PAGE Figure 5

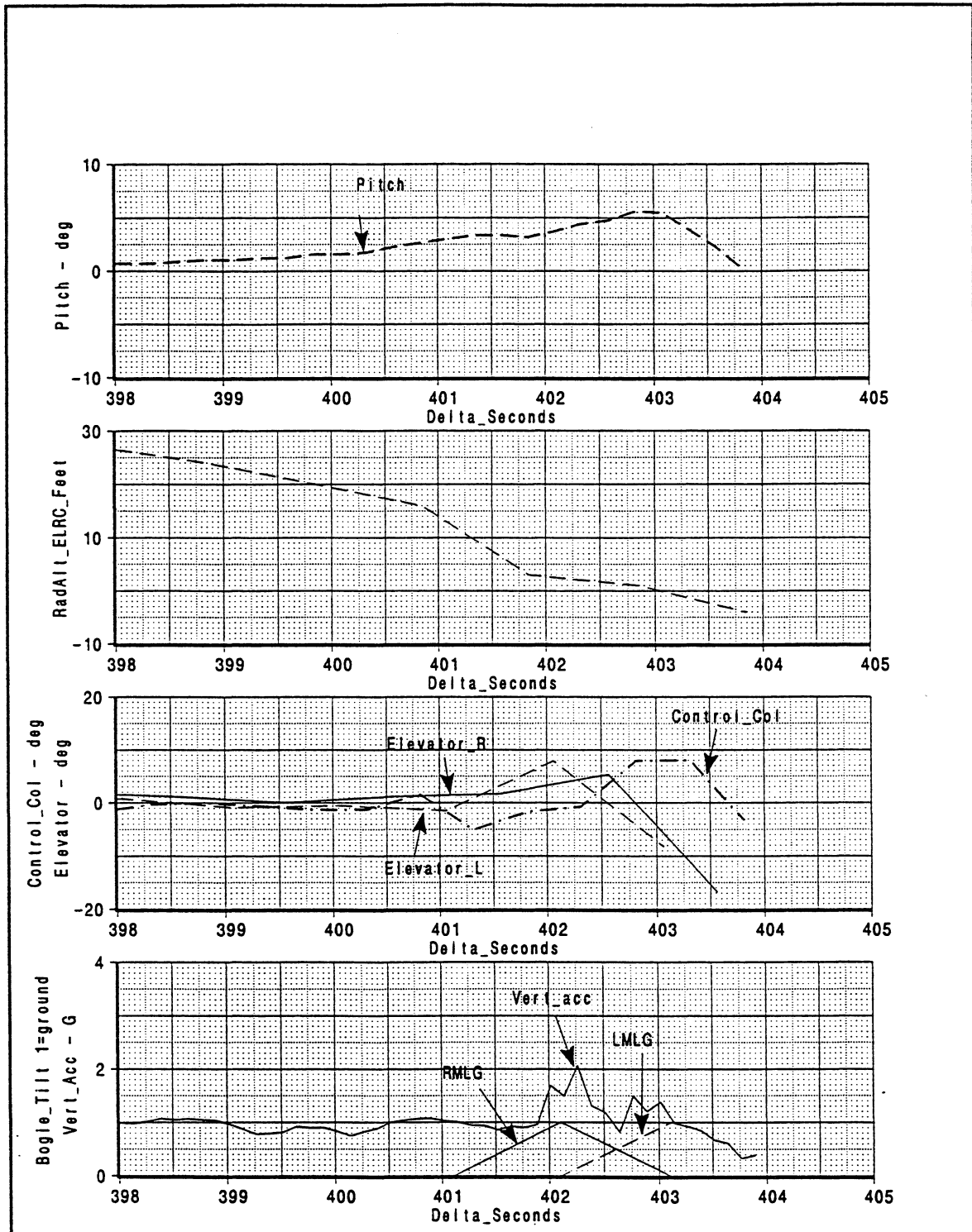

[A]: /acct/ccm1207/taac/tkc24127.esb

Thu Jul 30 1998 08:46:02

CALC	C. C. Ma	30Jul98	REVISED	DATE	TAV 757-200 PK-TKC/NB453 Landing Accident	757-200
CHECK					DFDR, Vertical parameters	
APPD.					Flare, Touchdown	
APPD.					BOEING	PAGE Figure 6

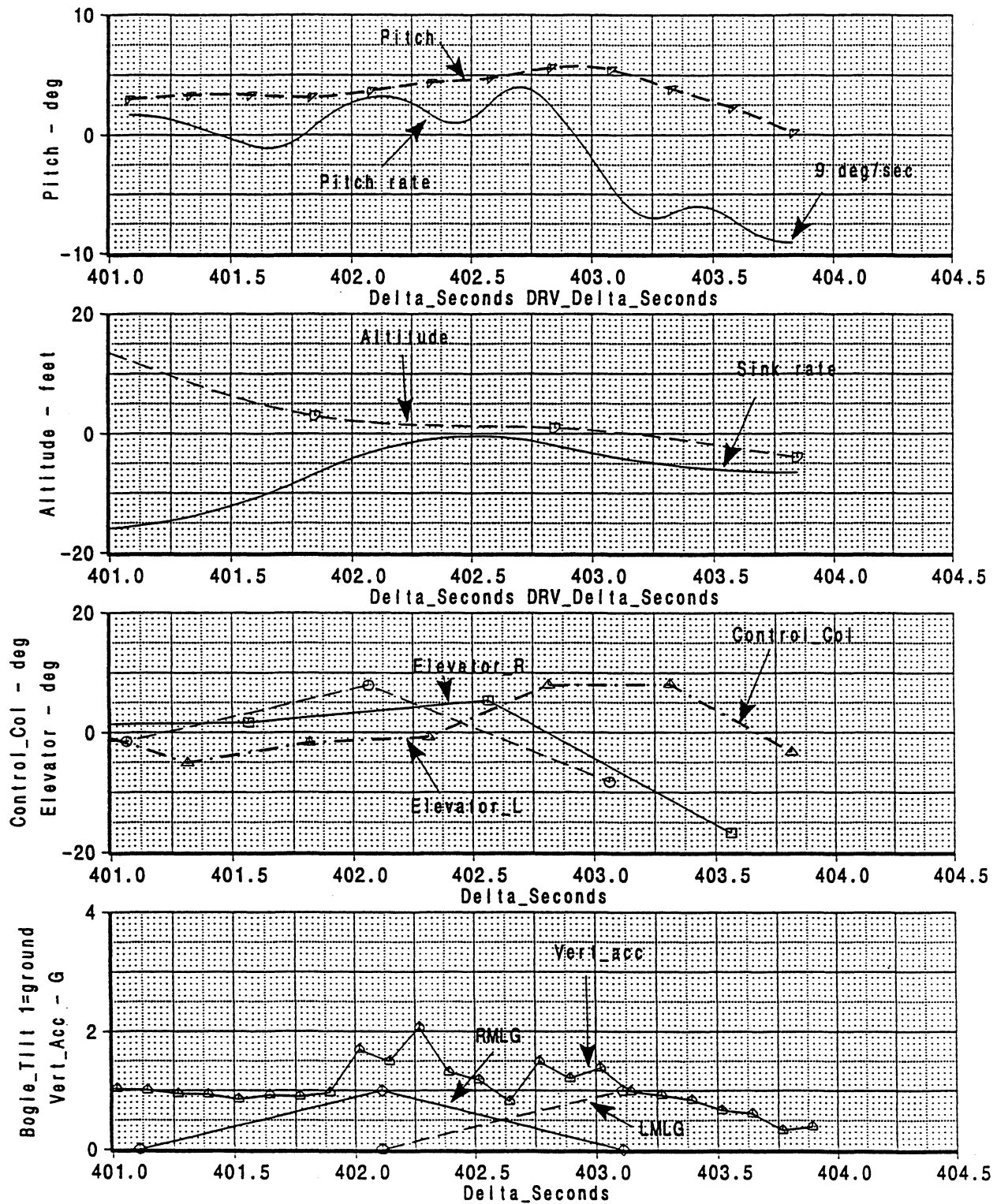

[A]: /acct/ccm1207/taac/tkc24127.esb

Tue Dec 8 1998 10:51:41

CALC	C. C. Ma	8Dec98	REVISED	DATE	TAV 757-200 PH-TKC/NB453 Landing Accident DFDR, Vertical parameters Flare, Touchdown	757-200
CHECK						
APPD.						
APPD.						
BOEING						PAGE Figure 7

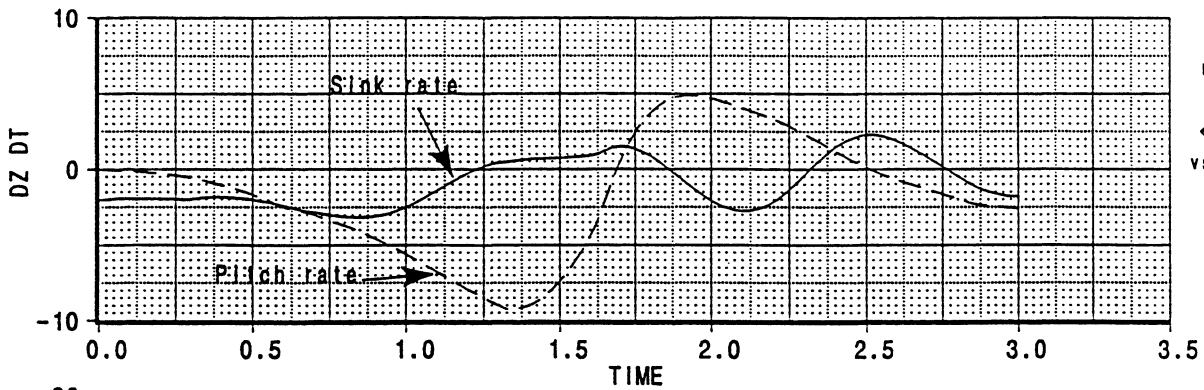

RUN 1003
DZ
DT
vs TIME

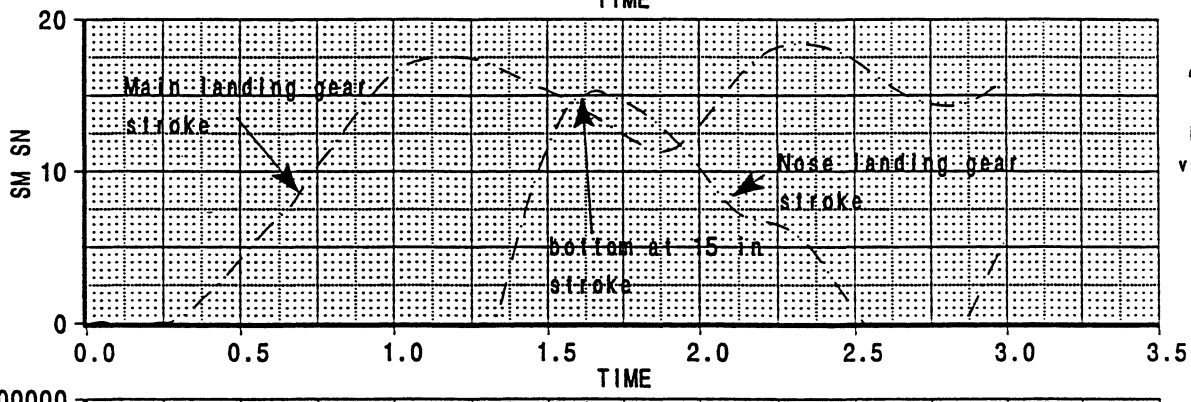

RUN 1003
SM
SN
vs TIME

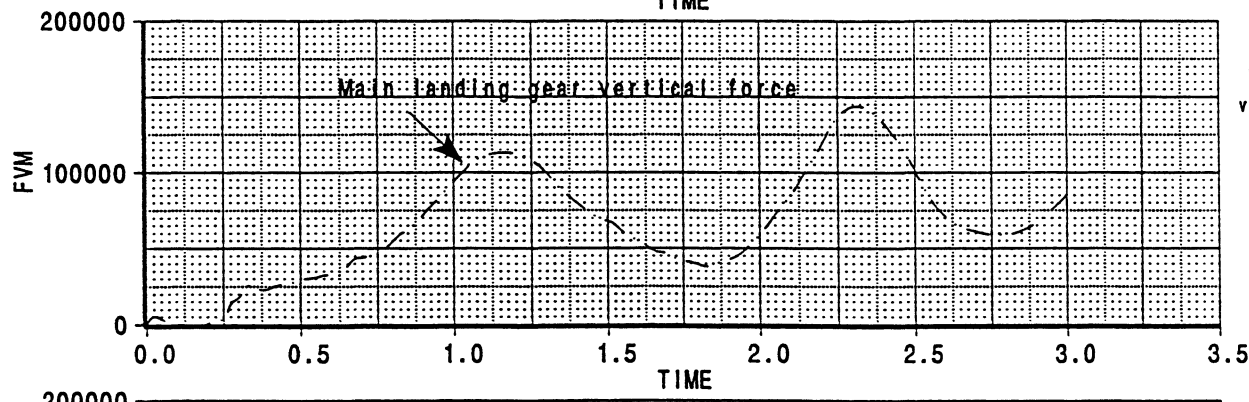

RUN 1003
FVM
vs TIME

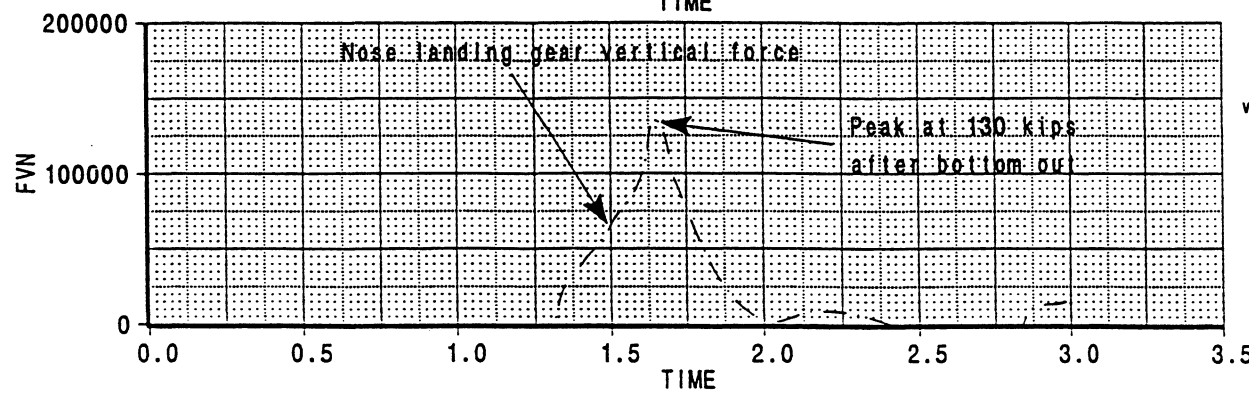

RUN 1003
FVN
vs TIME

[A]: /acct/ccm1207/taac/lcd/cmoute_7.esb

Fri Dec 4 1998 15:05:18

<table border="1"> <tr> <td>CALC</td> <td>C. C. MA</td> <td>4Dec98</td> <td>REVISED</td> <td>DATE</td> </tr> <tr> <td>CHECK</td> <td></td> <td></td> <td></td> <td></td> </tr> <tr> <td>APPD.</td> <td></td> <td></td> <td></td> <td></td> </tr> <tr> <td>APPD.</td> <td></td> <td></td> <td></td> <td></td> </tr> </table>	CALC	C. C. MA	4Dec98	REVISED	DATE	CHECK					APPD.					APPD.					<p>Dynamic landing simulation Simulate elev. input to achieve 9 deg/sec pitch rate at nose gear ground contact</p> <p style="text-align: center;">BOEING</p>	<p>757-200</p> <hr/> <p>PAGE Page 8</p>
CALC	C. C. MA	4Dec98	REVISED	DATE																		
CHECK																						
APPD.																						
APPD.																						

TAV 757-200 PH-TKC/NB453 LANDING ACCIDENT

757-200 NOSE LANDING GEAR CAPABILITY -
 ABSORBED ENERGY CONSIDERATIONS

FAR 25.725 shock absorption tests - 757-200 nose landing gear

We	38500	lbs	The effective weights used in the drop test
v	10	ft/sec	Sink rate
E	59783	lb-ft	Kinetic energy to be absorbed = $.5 * We / 32.2 * v * v$

FAR 25.727 reserve energy shock absorption tests - 757-200 nose landing gear

We	38500	lbs	The effective weights used in the drop test
v	12	ft/sec	Sink rate
E	86087	lb-ft	Kinetic energy to be absorbed = $.5 * We / 32.2 * v * v$

Boeing condition - pitch rate = 8 deg/sec, sink rate = 0 ft/sec.

W	198000	lbs	Design Maximum landing weight
I-yy	7284000	slug-ft ²	Design condition pitch inertia
dpsi	8	deg/sec,	0.139626 rad/sec, pitch rate
I-yymlg	8687281	slug-ft ²	Pitch inertia about main landing gear = $I_{yy} + M_{ap} * (L_{cgmlg}^2 + H_{cg}^2)$
E	84682	lb-ft	Kinetic energy to be absorbed = $.5 * I_{yy} * dpsi * dpsi$

TAV accident - pitch rate 9 deg/sec

Due to inadequate sample rate of DFDR, the 9 deg/sec pitch rate at nose landing gear ground contact is the best value that can be determined from data.

W	177820	lbs	Airplane weight
M _{ap}	5522	slug	Airplane mass
I-yy	5855000	slug-ft ²	Pitch inertia about cg - nominal
BSNLG	391	in	body station of nose landing gear
BSCG	1047.25	in	27.8% mac
BSMLG	1111.3	in	body station of main landing gear
L _{cgnlg}	656.25	in	54.6875ft, distance between a/p cg and nlg
L _{cgmlg}	64.05	in	5.3375ft, distance between a/p cg and mlg
L _{mlgnlg}	720.3	in	Distance between main landing gear and nose landing gear
H _{cg}	12.33	ft	Height of airplane cg above ground
I-yymlg	6852338	slug-ft ²	Pitch inertia about main landing gear = $I_{yy} + M_{ap} * (L_{cgmlg}^2 + H_{cg}^2)$
dpsi	9	deg/sec,	0.15708rad/sec, pitch rate

Energy to be absorbed from pitch rate alone

E	84537	lb-ft	Kinetic energy to be absorbed = $.5 * I_{yymlg} * dpsi * dpsi$
---	-------	-------	---

Energy due to sink rate is ignored due to uncertainty of data quality.

Energy input from elevator command

rho=	0.002378	lb/ft ³	Air density
Ve=	130	knot, or	219.57 ft/sec
q=	57.32	lb/ft ²	Dynamic pressure
qs=	111836.9	lb	q*s, s=1951 ft ² wing reference area
qsc=	1861152	lb-ft	q*s*c, c= reference wing mac=16.64 ft
cm_del_e	-0.02707		
M_.25mac	-50378	lb-ft	q*s*c*cm_del_e, pitch moment about wing .25 mac per degree of elevator deflection
M_mlg	-46348	lb-ft	q*s*c*cm_del_e, pitch moment about mlg per degree of elevator deflection
Sn	15	in	Nose landing gear maximum stroke
theta	0.020825	radian	minimum airplane pitch angular displacement to bottom out nose gear stroke, Sn/Lmlgnlg
E_elev	965	lb-ft	energy input per degree of elevator, M_cg*theta
del_e	20	degree	Average elevator deflection after nose gear ground contact
E	19303	lb-ft	Energy input from elevator, E_elev * del_e

Energy to be absorbed by nose landing gear from the kinetic energy of pitch rate, sink rate and elevator command

E= 103841 lb-ft

SUMMARY

	Kinetic Energy	Elevator Energy	Total Energy	Ratio to FAR 25.725
	lb-ft	lb-ft	lb-ft	
FAR 25.725	59783	59783		1.00
RESERVE ENERGY	86087	86087		1.44
BOEING CONDITION	84682	84682		1.42
TAV ACCIDENT 9 deg/sec	84537	19303	103841	1.74

- Maximum design energy limit is approximately 86,000 lb-ft

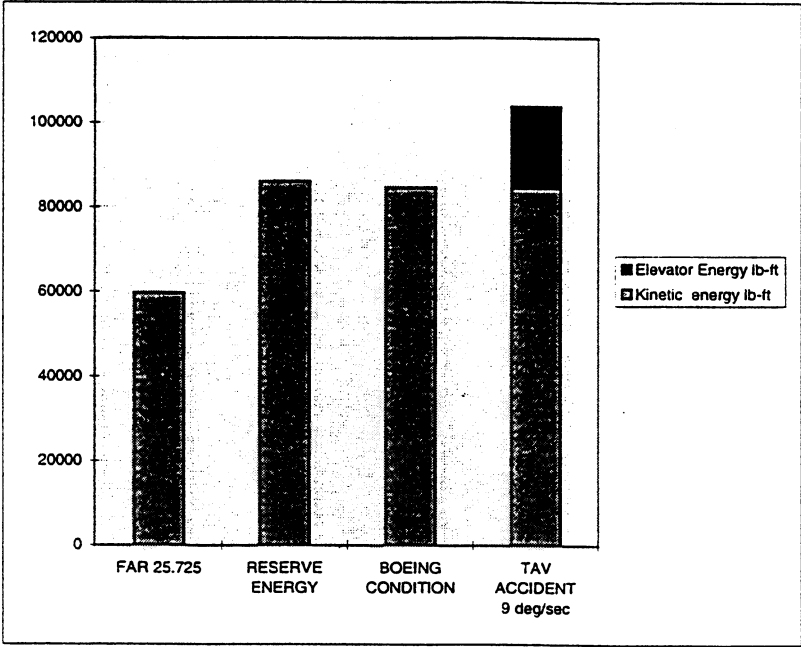

REPORT 97-75/A-26

APPENDIX 3.2

NLR-CR-98411 Failure analyses of a Boeing 757 NLG wheel well



NLR-CR-98411

Failure analysis of a Boeing 757 NLG wheel well

A. Oldersma

This investigation has been carried out under a contract awarded by the Netherlands Aviation Safety Board, contract number 985028/97-75/A-26/44.

No part of this report may be reproduced and/or disclosed, in any form or by any means without the prior written permission of the Netherlands Aviation Safety Board.

Division:	Structures and Materials
Issued:	28 September 1998
Classification of title:	Unclassified



Summary

During landing on 24 December 1997 the nose landing gear (NLG) installation of a Transavia Boeing 757-200 collapsed at touchdown. Inspection showed that the aft part of the nose landing gear wheel well (so-called doghouse) was broken loose from the surrounding structure.

The aft doghouse, the STA 324 and 395 lower bulkhead remnants and fuselage structure adjacent to the fracture were examined in more detail.

The fractures and deformation of the STA 324 and 395 bulkheads led to the following breakaway scenario:

Failure started with the buckling of the STA 395 frame, which enabled the aft side of the aft doghouse to displace in upward direction. The increased load on the STA 324 bulkhead resulted in deformation and fracture. After the aft doghouse separated from the STA 324 bulkhead, the aft doghouse rotated aft, thereby bending and twisting the STA 395 frame which ultimately resulted in fracture and complete separation of the aft doghouse.

Macro-examination of the fracture surfaces of the STA 324 and 395 bulkheads showed no indications of pre-existing cracks. Macroscopic features indicate overload as the fracture mechanism.



Contents

1	Introduction	5
2	Structure	6
3	Doghouse final position and preliminary breakaway scenario	7
4	Macroscopic examination	8
4.1	Aft doghouse	8
4.2	Bulkhead STA 324	8
4.3	Bulkhead STA 395	8
4.4	NLG attachment fittings and pins	9
5	Discussion	10
6	Conclusions and recommendations	12

5 Tables

14 Figures

(23 pages in total)



1 Introduction

During landing the nose landing gear (NLG) installation of a Transavia Boeing 757-200 collapsed at touchdown. The accident occurred on 24 December 1997 at Schiphol Airport and the airplane involved had registration PH-TKC. The NLG is attached to the nose wheel well. This wheel well (so-called doghouse) is tied to the fuselage at body station (STA) 263, 324 and 395 frames.

The aft doghouse support structure fractured at STA 324 and STA 395. Parts of the STA 395 frame were still attached to the aft doghouse. The NLG assembly remained extended and locked in place. After fracture the aft doghouse rotated, resulting in a downward and aft movement of the front side and a forward and upward movement of the doghouse aft side. As a result of the rotation the forward side of the aft doghouse had contacted the runway and was worn away.

The Netherlands Bureau of Accident and Incident Investigation (BVOI) requested the NLR to determine the breakaway sequence and inspect the STA 324 and 395 bulkheads for possible pre-existing defects.



2 Structure

The NLG is attached to the wheel well, which is a rigid box structure (so-called dog house). A schematic of the doghouse is shown in figure 1. The dog house consists of a forward and an aft part and is tied to the fuselage main structure at bulkheads STA 263, STA 324 and STA 395. These bulkheads are part of the nose wheel well structure. A left side view of the doghouse showing the NLG attachment fittings is given in figure 2. The NLG main strut attachment fitting is located at A, see figure 2, and the drag brace attachment fitting at location B.

During the landing the NLG is subject to upward, fore-aft loads and sideloads.

The major part of the vertical (upward) loads is led into the fuselage structure by the STA 395 bulkhead. Therefore the lower part of bulkhead STA 395, which incorporates the aft side of the doghouse, is constructed as a rigid beam. This rigid lower half of the STA 395 bulkhead is used to lead the concentrated upward load into the fuselage side-wall.

The fore-aft loads result in reactive fore-aft loads in the attachment fittings and a moment which will partly be reacted by vertical loads in the STA 324 and 395 bulkheads. An aft load results in a downward load on bulkhead 324 and an upward load on bulkhead 395.



3 Doghouse final position and preliminary breakaway scenario

The forward doghouse, located between STA 263 and STA 324, remained attached to the fuselage. The aft doghouse completely broke loose from the surrounding structure. The NLG assembly remained extended and rotated aft and slightly to the right. The NLG wheels were pressed against the fuselage belly just right with respect to the centre line (plane of symmetry). The left steering actuator cylinder housing, attached to the NLG shock strut was worn at the lower right side which is consistent with the position of the NLG strut while travelling the runway.

The top side of STA 395 bulkhead damaged some floor beams.

Based on the preliminary results of the in-situ inspection, the BVOI suggested the following scenario:

After fracture the aft doghouse rotated, resulting in a downward and aft movement of the front side and a forward and upward movement of the doghouse aft side. The forward side of the aft doghouse contacted the runway was worn away. At the left hand side of the aft doghouse a larger part was worn away which indicates an inclined position with respect to the aircraft plane of symmetry, while it was dragged over the runway surface.



4 Macroscopic examination

The aft doghouse, the STA 324 and 395 bulkhead remnants and fuselage structure adjacent to the fracture were selected for detailed examination. Since some parts had to be cutout or were needed during the repair, the selected remnants came available afterwards. The following parts were sent to the NLR and used for examination:

1. The aft doghouse, including remnants of the 395 bulkhead.
2. The aft section of the forward doghouse which contained the forward-aft doghouse fracture surface (the mating fracture surface was at the forward side of the aft doghouse and was worn away)
3. Part of the fuselage belly located aft and adjacent to the STA 395 bulkhead (parts of the 395 bulkhead outer chord were attached to this part.
4. STA 324 lower bulkhead remnants which were still attached to the fuselage.
5. STA 395 lower bulkhead remnants which were still attached to the fuselage.
6. Skin sections at STA 395, cutout from the fuselage.

4.1 Aft doghouse

The forward part of the aft doghouse was worn away. The extent of the wear damage indicates the final position of the aft doghouse, see figures 3 and 4.

4.2 Bulkhead STA 324

An overview of the fracture at STA 324 is shown in figure 5. The aft side of the top plate of the forward doghouse adjacent to the STA 324 frame was pressed in forward direction and buckled (see Fig. 6), indicating a forward displacement of the top side of the aft doghouse. At the lower side the web was pulled aft (see Fig. 5).

At both the RH and LH side the bulkhead outer chords in the stringer 21-22 area showed local buckling, see figures 7 and 8.

Macroscopic examination of the available web and chord fracture surfaces indicated overload as fracture mechanism.

4.3 Bulkhead STA 395

An overview of STA 395 bulkhead remnant including the aft side of the doghouse is given in figure 9. A schematic of the STA 395 bulkhead with the web fracture locations is shown in figure 10. The dashed areas are crushed areas. The LH and RH fracture locations are shown in figures 11 and 12.



Since the NLG main strut fitting is close to STA 395 the major part of the vertical NLG loads is led into the STA 395 bulkhead, which includes the aft side of the aft doghouse.

Figures 13 and 14 show disassembled parts of the STA 395 bulkhead which were still attached to the fuselage structure. The chords of the RH side bulkhead section had been removed, so only the web was available for examination, see figure 14. Both the LH and the RH bulkhead sections were buckled between stringer locations 19 and 21. The lower sides of the bulkhead sections were twisted conform the rotation of the doghouse.

When the aft doghouse broke loose from the fuselage structure, a section of the fuselage belly located aft and adjacent to the STA 395 bulkhead was also torn loose from the fuselage and still attached to the STA 395 bulkhead. Before it was transported to the NLR this section was cut loose for handling purposes. A part of the STA 395 bulkhead chord was still attached to this section.

Macrofractography of the STA 395 bulkhead remnants showed no indications of pre-existing cracks.

4.4 NLG attachment fittings and pins

The BVOI asked the NLR to check the NLG pins and attachment fittings for any deformation which could be related to the incident.

Visual inspection of the pins and fittings did not show any defects. The outer diameter of the two NLG main strut-doghouse, the two drag brace-doghouse attachment pins and the drag brace upper part-lower part connecting pin were determined. Of each pin five locations in pin lengthwise direction were selected. At each location the pin diameter was measured in two mutual perpendicular directions. The results are listed in tables 1 to 3. No shear and no bending deformations in cross or lengthwise direction was found.

The inner diameters of the drag brace and main strut attachment fittings were measured. Each fitting was measured at four locations and two measurements per location. The results are listed in tables 4 and 5. No discrepancies were found.



5 Discussion

The inspection of the doghouse and surrounding structure was focused on the STA 324 and STA 395 bulkheads since these two bulkheads are the main NLG load carrying bulkheads.

Macro-examination of the fracture surfaces of the STA 324 and 395 bulkheads showed no indications of pre-existing cracks. Macroscopic features indicate overload as the fracture mechanism.

The damage pattern which was schematically shown in figure 10 indicated a fairly symmetrical failure behaviour. The buckling in the stringer 20 area of the STA 395 bulkhead was only possible when a compressive load was applied. This load application could only have taken place before fracture of the STA 395 bulkhead. Since the STA 395 bulkhead sections, adjacent to the broken out part of the STA 395 bulkhead, showed twisting deformation, this means that complete fracture of the STA 395 bulkhead (and final separation of the doghouse) occurred during rotation of the bulkhead.

A failure scenario in which failure starts with fracture of the STA 324 bulkhead would also lead to rotation of the doghouse and deformation and fracture of the STA 395 bulkhead. Deformation of the STA 395 bulkhead combined with acting upward load on this bulkhead could also favour buckling of the STA 395 bulkhead in the stringer 20 area. However, the buckling deformation is expected to be different.

The buckling location of the STA 395 bulkhead is at the location where the rigid lower part of the bulkhead continues into a section where the frame reaches its minimum height. In case of an upward overload this probably will be the normal location of buckling.

The fractures and deformation of the STA 324 and 395 bulkheads led to the following breakaway scenario:

A large vertical load resulted in buckling of the STA 395 frame. The buckling decreased the load carrying capacity of this bulkhead and enabled the aft side of the aft doghouse to displace in upward direction. The aft directed load on the NLG resulted in a rotational moment and an aft directed load on the aft doghouse. The rotational moment caused pivoting of the aft doghouse around frame 395. As a consequence, the upper forward edge of the aft doghouse moved forward and down, causing buckling of the aft part of the forward doghouse top plate, and the lower forward edge of the aft doghouse moved down and aft, causing deformation in aft direction of the lower part of the STA 324 bulkhead and local buckling of the STA 324 frame outer chord in the stringer 21-22 area. Subsequently the continuing rotation of the aft doghouse



resulted in fracture of the aft doghouse-to-frame STA 324 attachment. The separation at STA 324 enabled the aft doghouse to rotate further aft, thereby bending and twisting the STA 395 frame which ultimately resulted in fracture and complete separation of the aft doghouse.

Available flight data showed accelerations & velocities of the airplane until the moment of touchdown. However, these data refer to the movements of the airplane's centre of gravity. Major factors in the nose landing gear vertical loads are the angular velocity and angular acceleration about the aircraft pitch axis. Since there is no information available about these parameters in this particular flight and the values normally occurring in flight, there is no indication whether the landing was exceptional severe, within, or just beyond limits. Moreover, it is not possible to compare the landing to the 757 design load cases.



6 Conclusions and recommendations

Inspection of the broken-out aft doghouse and the surrounding structure and macro-examination of the STA 324 and STA 395 bulkhead fractures led to the following conclusions:

1. Macro-examination of the fracture surfaces of the STA 324 and 395 bulkheads showed no indications of pre-existing cracks. Macroscopic features indicate overload as the fracture mechanism.
2. The breakaway sequence started with buckling of the STA 395 bulkhead at both the RH and LH side in the stringer 20 area.
3. The NLG pins and attachment fittings did not show any bending deformations in cross or lengthwise direction.

In view of the results it is recommended to obtain data of in-service NLG loads and compare them with the NLG design loads. Furthermore it is recommended to look at the stress analysis reports to determine whether it is likely that loads exceeding the design loads will lead to buckling of the STA 395 bulkhead in the stringer 20 area.



Table 1 Outer diameter of the NLG main strut attachment pins

Location	P/N 162N1185-5 R/H		P/N 162N1185-5 L/H	
	A	63.455	63.456	63.460
B	63.459	63.460	63.463	63.463
C	63.456	63.454	63.470	63.450
D	63.452	63.469	63.460	63.462
E	63.452	63.470	63.464	63.465

Table 2 Outer diameter of the drag brace attachment pins

Location	P/N 162N2303-4 HM4442		P/N 162N2303-4 HM4443	
	A	58.396	58.398	58.388
B	58.395	58.399	58.390	58.385
C	58.396	58.402	58.399	58.399
D	58.394	58.399	58.398	58.398
E	58.395	58.395	58.396	58.396



Table 3 Outer diameter of the drag brace upper-lower part connecting pin

Location	P/N 162N2301-2 HM105	
A	50.754	50.755
B	50.754	50.755
C	50.757	50.753
D	50.754	50.755
E	50.758	50.755

Table 4 Drag brace attachment fittings

Location	RH-side		LH-side	
A	58.470	58.463	58.479	58.480
B	58.468	58.465	58.483	58.479
C	58.466	58.471	58.494	58.485
D	58.506	58.512	58.527	58.508

Table 5 Main NLG strut attachment fittings

Location	RH-side		LH-side	
A	63.597	63.650	63.604	63.619
B	63.528	63.521	63.605	63.617
C	63.527	63.536	63.596	63.626
D	63.650	63.694	63.782	63.825

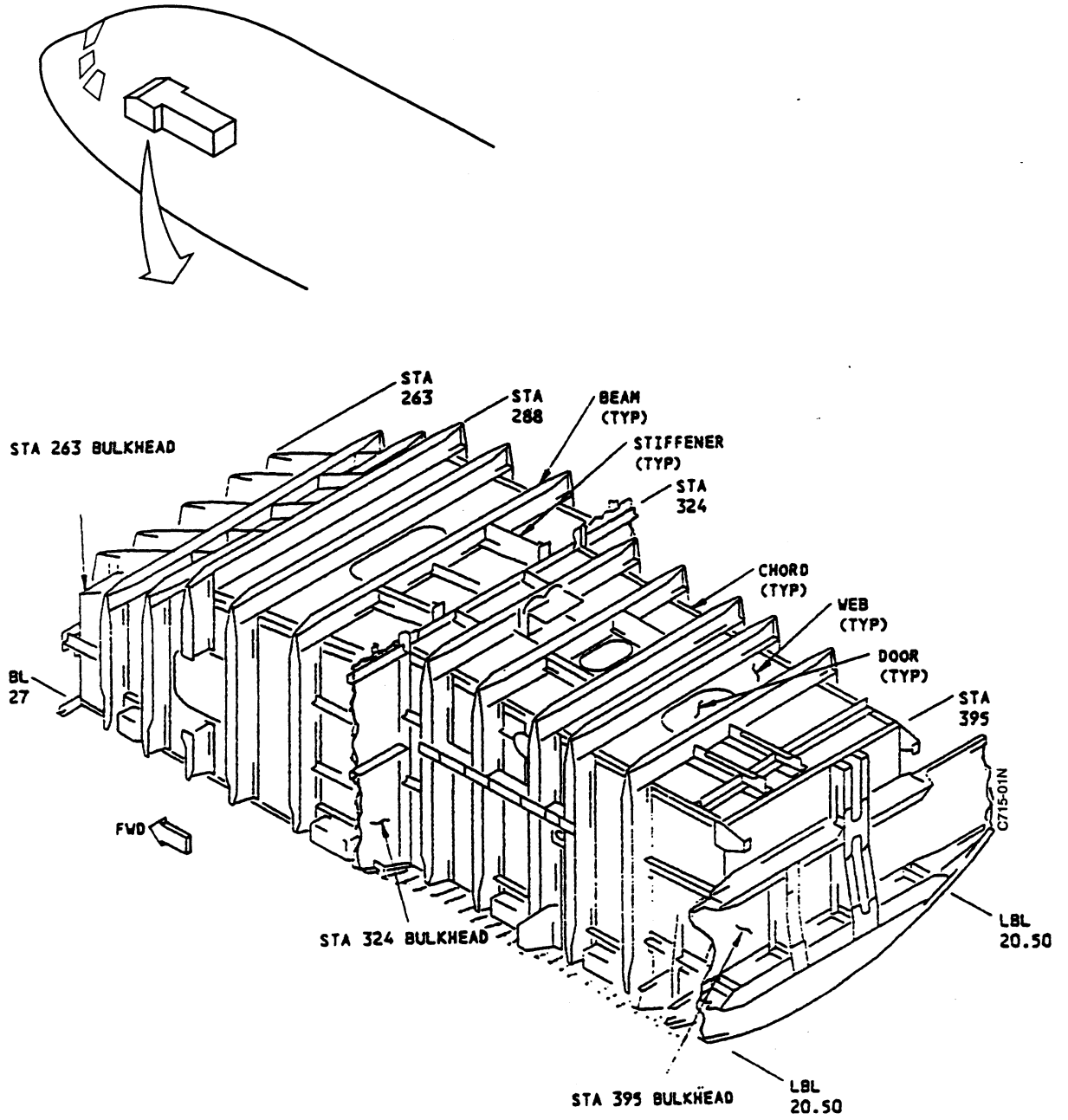

Fig. 1 Nose wheel well structure

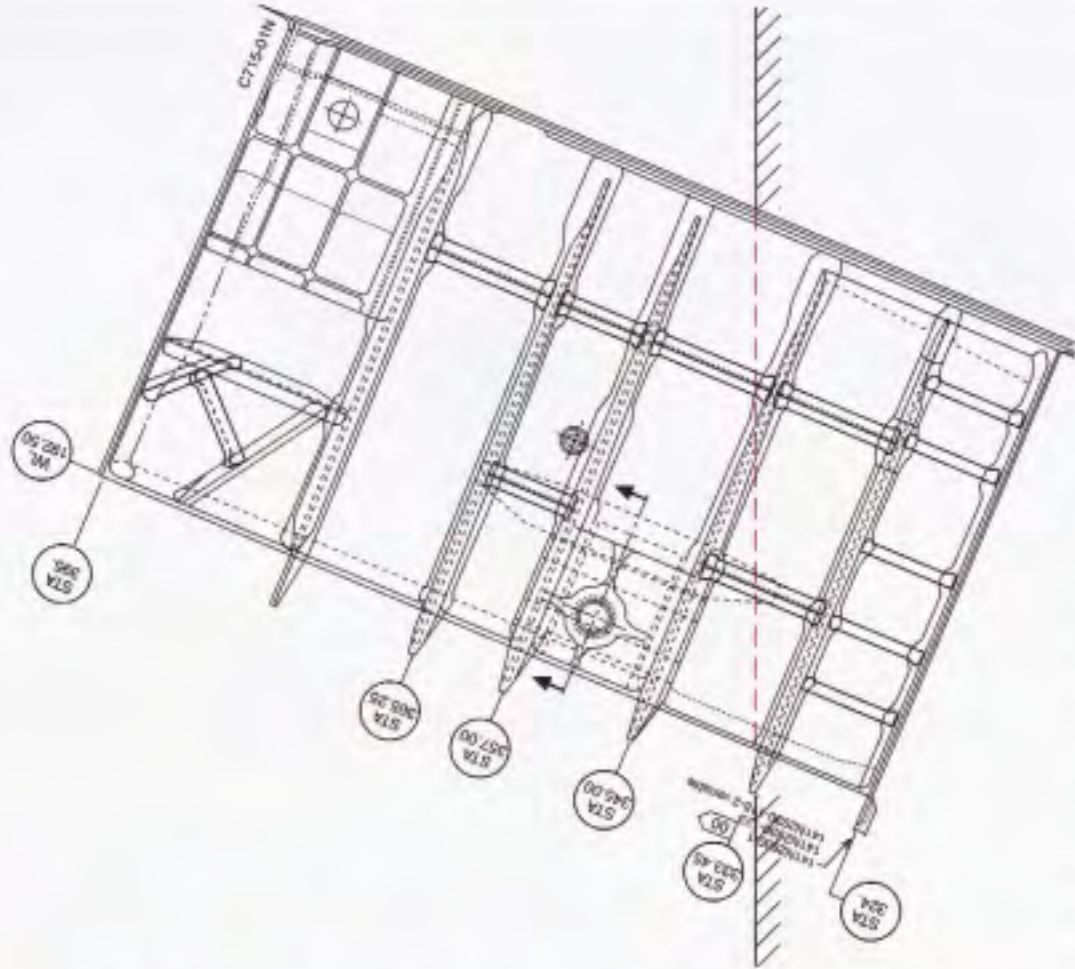

Fig. 4 Schematic of the aft doghouse in final position

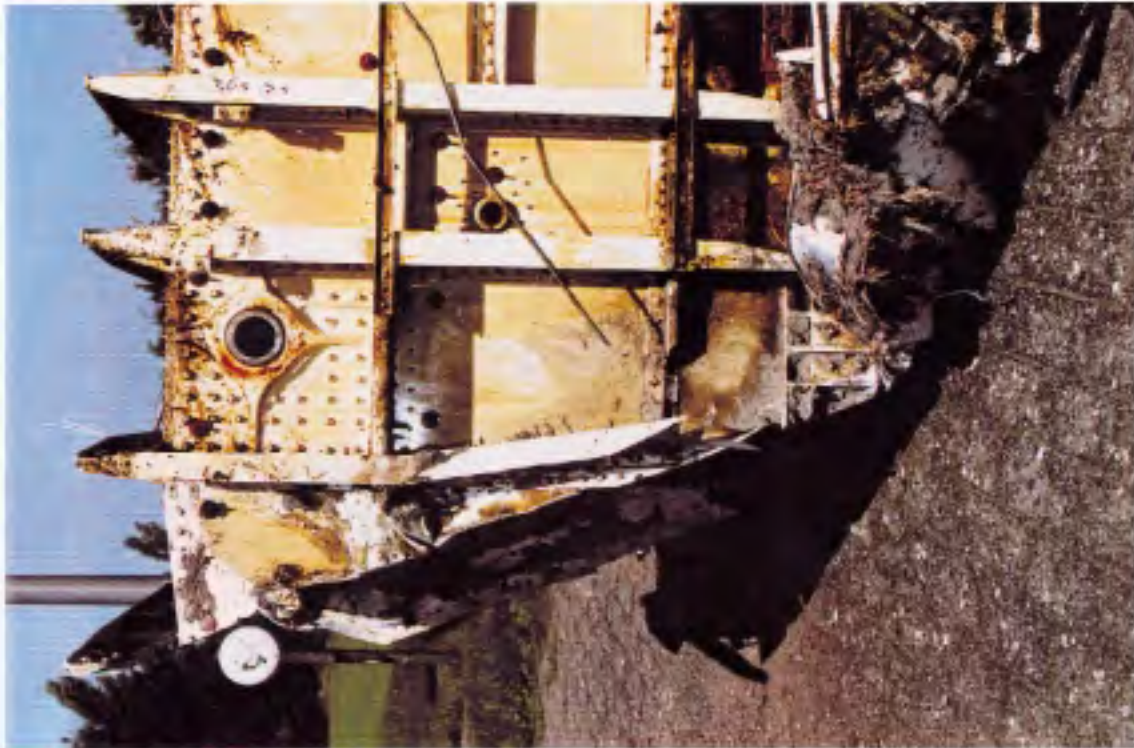

Fig. 3 Side view of the aft doghouse

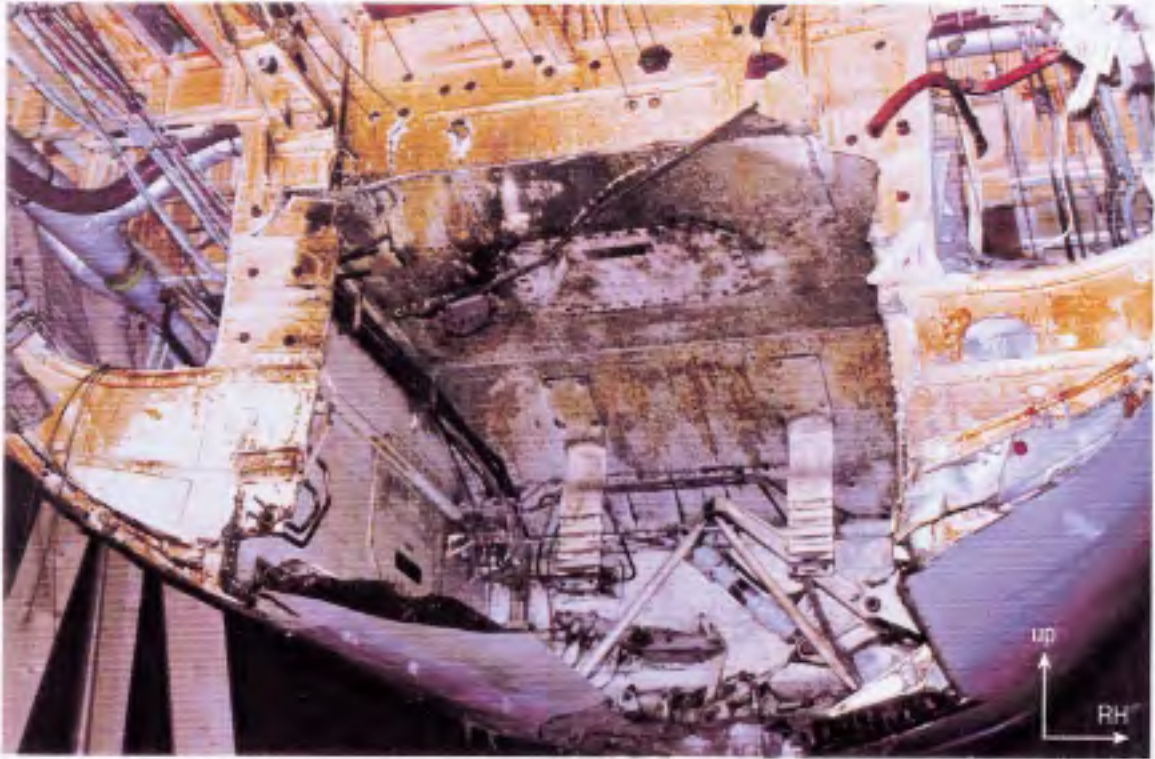

Fig. 5 Lower part of the STA 324 bulkhead

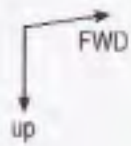

Fig. 6 Aft part of the forward doghouse
and part of the STA 324 bulkhead
(upside down position)

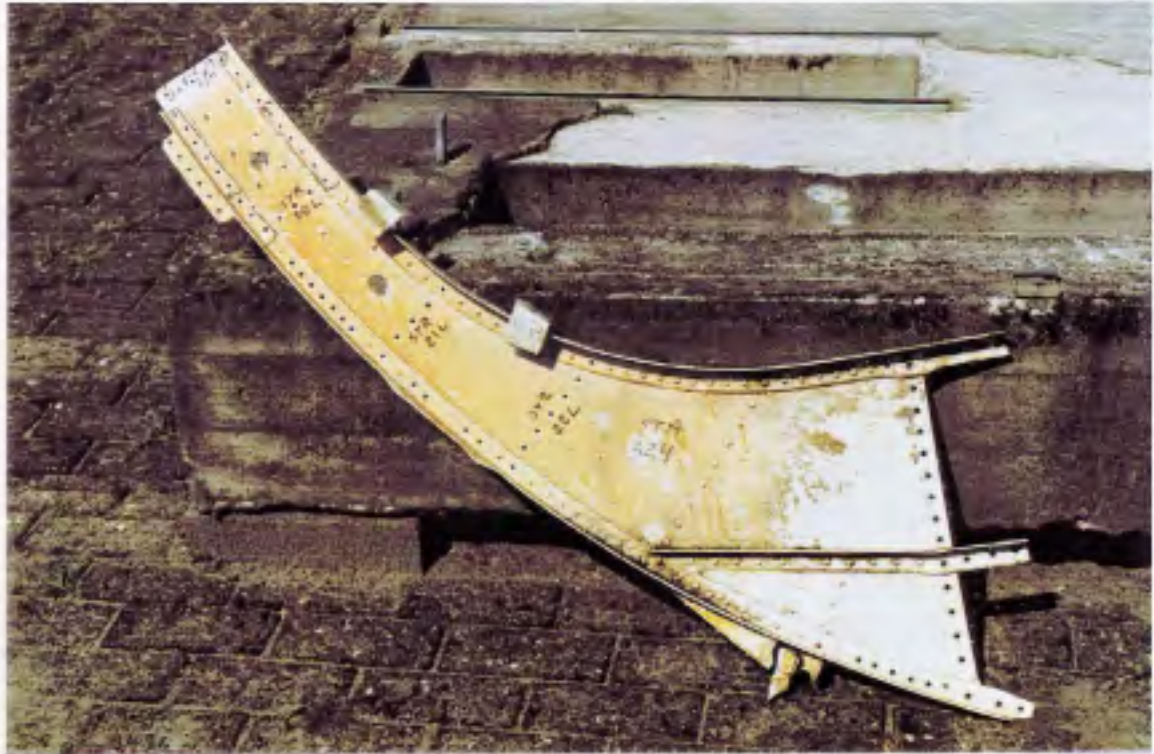

Fig. 7 Section of the STA 324 bulkhead (LH-side)

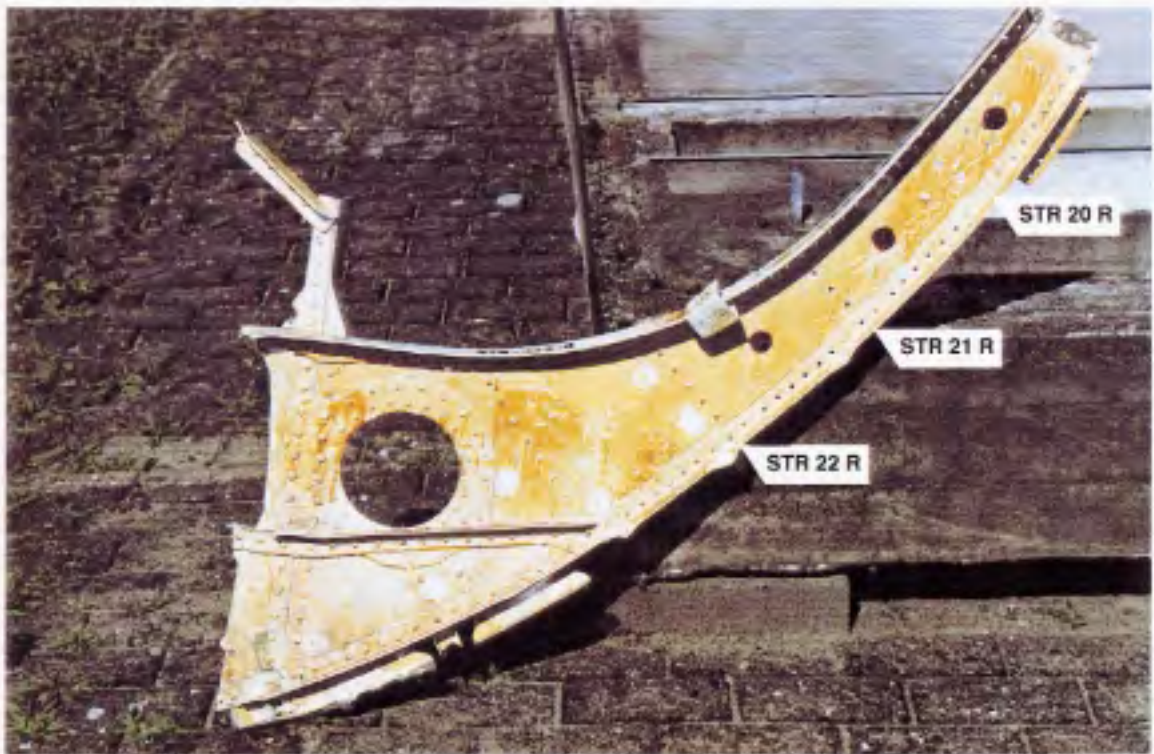

Fig. 8 Section of the STA 324 bulkhead (RH-side)

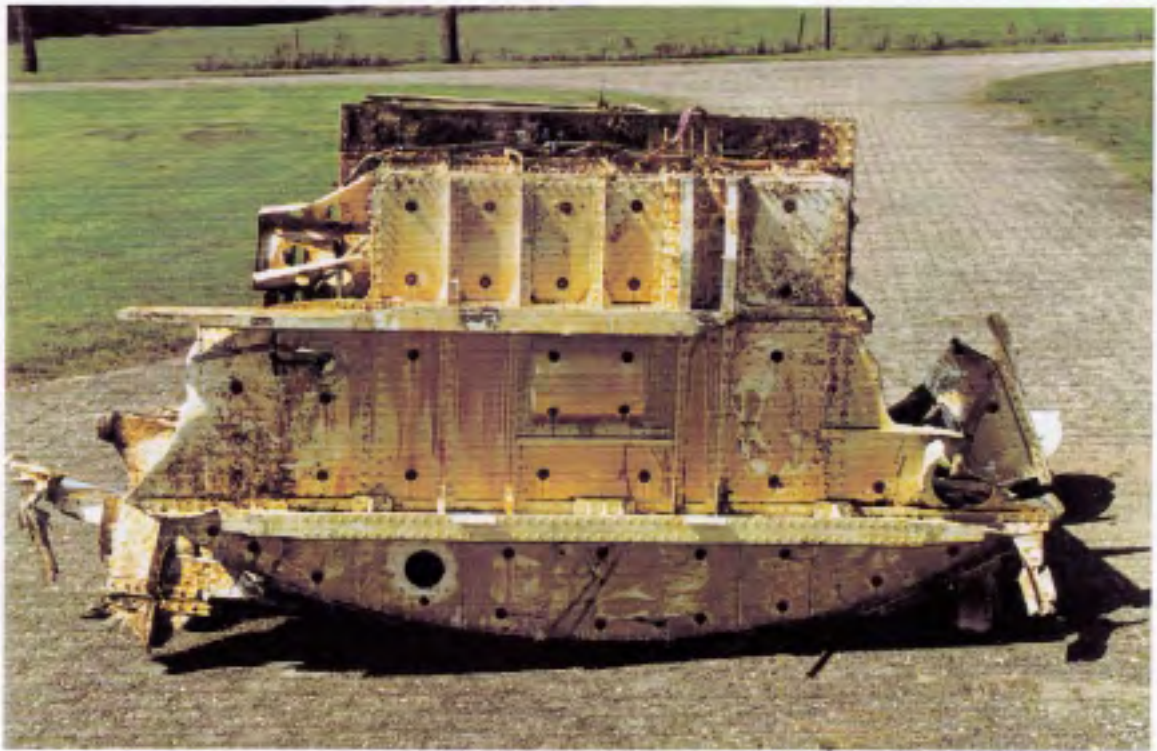

Fig. 9 Aft side of the aft doghouse

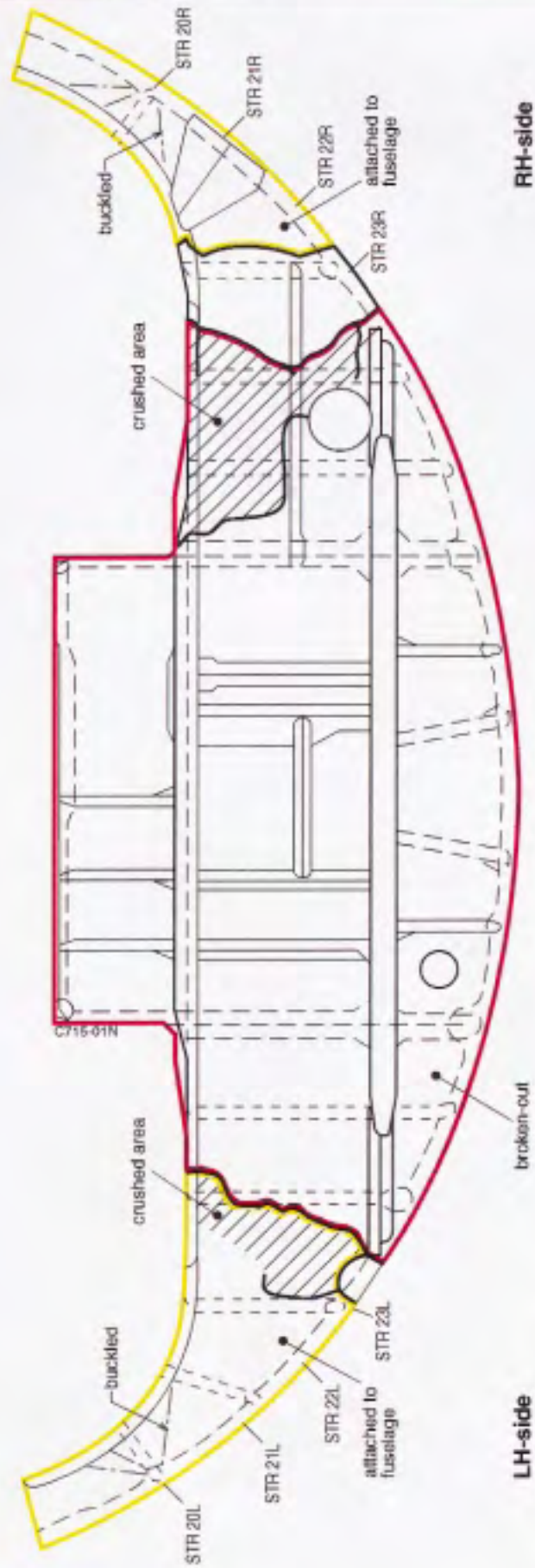

Fig. 10 Schematic of the lower STA 395 bulkhead with web fracture locations indicated



Fig. 12 Detail of the STA 395 bulkhead (RH-side)

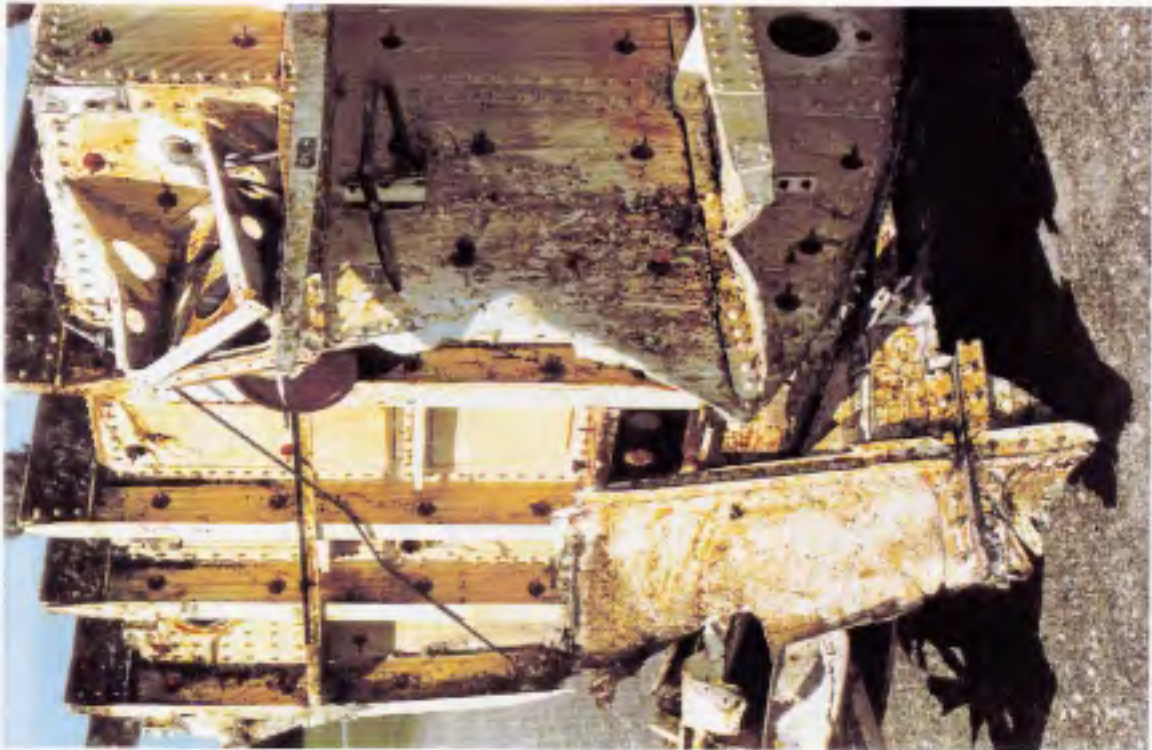

Fig. 11 Detail of the STA 395 bulkhead (LH-side)



Fig. 14 Section of the STA 395 bulkhead (RH-side)

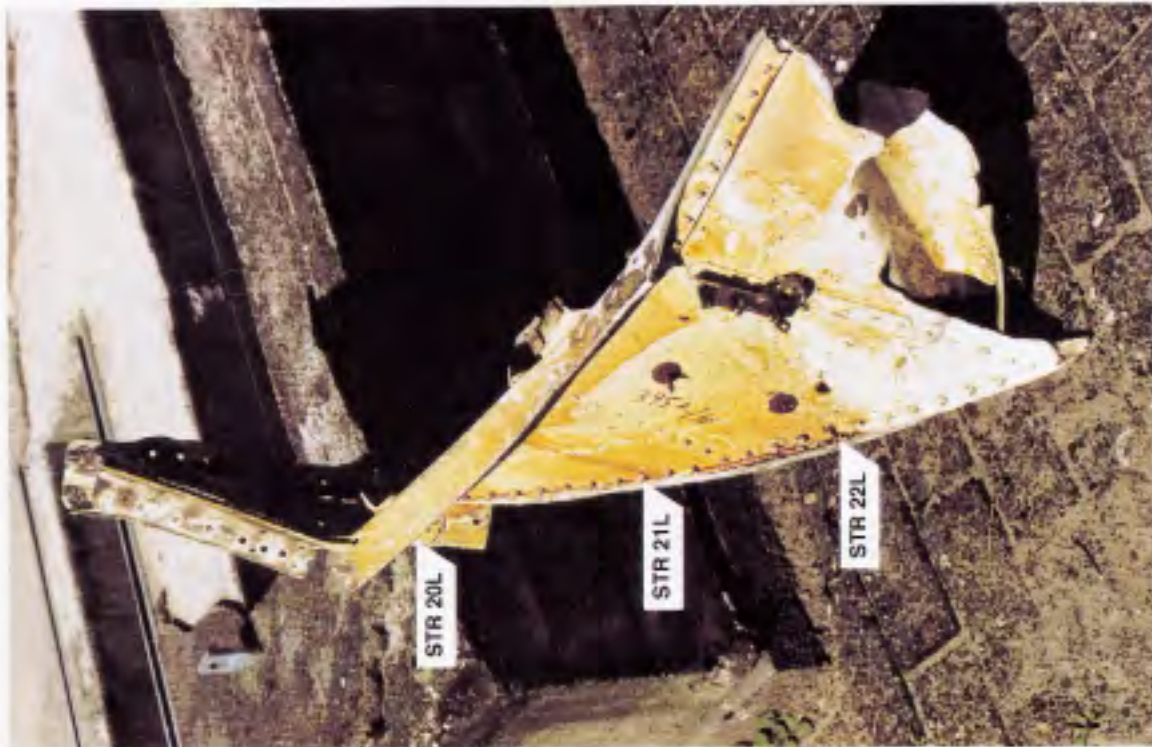

Fig. 13 Section of the STA 395 bulkhead (LH-side)

REPORT 97-75/A-26

APPENDIX 3.3

NLR investigation into windshear



Raad voor de Luchtvaart
T.a.v. de heer. F.J. Erhart
Bruggebouw-West
Prins Clauslaan 18
2595 AJ DEN HAAG

behandeld door
H. Haverdings/rc

telefoon
020 5113297

ons ordernummer
149.820

ons kenmerk
VH/3661

Datum

18 DEC. 1998

onderwerp
Ongeval Transavia PH-KTC

Bijlage: 1

Geachte heer Erhart,

Middels deze brief melden wij u de resultaten van het onderzoek dat door het NLR verricht is ter zake van het ongeval met de Transavia Boeing 757, de PH-TKC, op 24 december 1997. In uw opdracht middels brief d.d. 12 maart 1998, en bevestigd met uw brief d.d. 24 april 1998, in antwoord op NLR-fax VH/52484/F d.d. 30 maart 1998, werd het NLR verzocht ten eerste na te gaan of er windshear aanwezig was ten tijde van het ongeval, en ten tweede analyses van tijdreeksen van bepaalde vluchtgegevens uit te voeren. Enkele zaken die tijdens het onderzoek van de vluchtgegevens opvielen, zijn nader beschouwd. De resultaten van dit onderzoek zijn, in de vorm van o.a. figuren, gegeven in een tweetal bijlagen bij deze brief. Gaarne zijn wij bereid één en ander verder mondeling toe te lichten.

Bespreking van de resultaten is gegeven in de hierna volgende punten.

1. Algemeen

De ontvangen vluchtgegevens zijn zonder vermeldenswaardige problemen verwerkt. Er is een aparte kalibratie van de invalshoekmeters uitgevoerd voor elk van de drie flap settings (5, 20 en 30 graden), teneinde de ware invalshoek te kunnen bepalen. Deze kalibratiegegevens waren niet beschikbaar, of aangeleverd door Boeing. Ten aanzien van de sliphoeck is eveneens een bepaalde kalibratie toegepast, door te stellen dat 0.1g laterale versnelling overeenkomt met 10 graden sliphoeck. Uit de, later door Boeing geleverde, stabiliteitsafgeleiden kon eveneens een schatting worden gemaakt, maar deze bleek irreële waarden voor de hiermee berekende sliphoeck op te leveren. Deze methode is derhalve niet toegepast.

2. Windsituatie

De windsnelheid en -richting (in 3 componenten, namelijk langs, dwars en vertikaal ten opzichte van de landingsbaan) werd berekend met behulp van een zogenaamde 3-dimensionale (3-D) berekening. Dit wil zeggen dat zowel de invalshoeck als de sliphoeck, de standhoeck en de rolhoeck zijn gebruikt om de windsnelheidsvector te berekenen, naast de overige grootheden zoals luchtsnelheid, grondsnelheid, etc.

Postadres
Postbus 90502
1006 BM Amsterdam

NLR Amsterdam
Anthony Fokkerweg 2, 1059 CM Amsterdam
Telefoon (020) 511 31 13, Fax (020) 511 32 10

NLR Noordoostpolder
Voorsterweg 31, 8316 PR Marknesse
Telefoon (0527) 24 84 44, Fax (0527) 24 82 10

aan
Raad voor de Luchtvaart
ter attentie van
de heer F. Ehrhart

ons kenmerk
VH/3661

datum
18 DEC. 1998



Daarnaast is ook de zogenaamde 2-dimensionale (2-D) methode toegepast, namelijk die welke ook wordt toegepast in het FMS van de B757 uitgevoerde berekeningen. Hierbij worden alleen de koers, drift, grondsnelheid en luchtsnelheid gebruikt.

Uit de 3-D methode blijkt een windverloop waarin enige windshear aanwezig was, maar die praktisch gesproken te verwaarlozen is. De zogenaamde 'F-factor', die een maat is voor de "zwaarte" van de windshear, bleef te allen tijde ver beneden het waarschuwningsniveau (zie figuur 6 in Appendix A).

De eerste vier figuren in Appendix A geven, voor de laatste 36 seconden van de landing, de windsnelheid, -richting, headwind en crosswind componenten weer. Naast de door het NLR berekende wind, zijn tevens geplot de 12" (12 seconden) gemiddelde waarde van deze wind, en de door de meteo geleverde 12" wind voor baan 19R. De verticale wind (figuur 5 in Appendix A) laat zien dat er wel enige stijg- en daalwinden waren, maar niet van belangrijke grootte. Bovendien is met de toegepaste methode er gemiddeld nog een constante waarde aanwezig. De maximale stijgwind bedroeg ca. 200 ft/min ten tijde van OM passage (tijd ongeveer 22:46:30 UTC).

Opvallend is dat er een praktisch constant verschil aanwezig was tussen de 3-D berekende en 2-D berekende windsnelheid (alleen getoond voor de crosswind in figuur 4). In de crosswind kwam dit tot uiting, doordat volgens de 3-D methode de crosswind op het moment van landen ca. 40 kt bedroeg, terwijl met de 2-D methode (de zgn. B757 lijn in de figuur) deze uitkwam op ca. 20 kt.

Ten aanzien van de aanwezigheid van windshear laat de "windshear hazard factor", de zgn. F-factor (in figuur 6 van Appendix A) zien dat nergens de kritische waarde van -0.105 wordt overschreden. Deze waarde behoort bij een tijdsmiddeling van 12 seconden, overeenkomstig voorschrift Technical Standard Order TSO-C117. De "piek"waarde aan het einde van de tijdreeks treedt meestal op doordat onder invloed van het grondeffect een verandering in de invalshoek optreedt. Deze wordt vaak ten onrechte vertaald in een windverandering, die dan als windshear wordt gekenmerkt.

3. Meteogegevens

Verder zijn van de Luchtvaart Meteorologische Dienst Schiphol de meteogegevens (windsnelheid en -richting) ontvangen van alle banen op Schiphol. De windsnelheid en -richting voor baan 19R zijn tevens geplot in de figuren. Wat opvalt is dat volgens de "meteo" de wind meer in de richting van de baan lag dan volgens de NLR-berekeningen. Gemiddeld was de 3-D headwind ca. 5 m/s (10 kts) lager, en de 3-D crosswind ca. 20 kts (!) hoger. Ten aanzien van de crosswind situatie gaf dus de meteo en de B757 een gunstiger beeld (namelijk minder crosswind) dan berekend door het NLR.

Verder bleek uit een controleberekening dat de 1-minuut en 10-minutengemiddelde windsnelheid, berekend uit de 12-seconden samples van de windsnelheid, gemiddeld 1.5-2.0 m/s hoger lagen dan de door de meteo verstrekte 1-minuut en 10-minutenwaarden van de windsnelheid. Dit gold voor alle banen. Het grootste verschil bestond voor baan 01L, en het kleinste verschil voor baan 22. Het is niet bekend waar dit gemiddeld verschil vandaan komt (qua verloop met de tijd was er een zeer goede overeenkomst tussen de berekende en de gemeten 1- en 10-minutenwaarden).

4. Verder onderzoek naar het besturingssysteem

Na een bespreking op 2 november 1997 op het NLR werd, meer gericht op het moment van landen, verder onderzoek gedaan naar de wijze waarop het vliegtuig zich gedroeg, mede als gevolg van de variabele wind. In dit verband bleek het noodzakelijk een besturingssysteem, met hydraulica, te ontwerpen als systeem tussen de cockpitstuuruitslagen, en de roeruitslagen als gevolg daarvan. De resultaten van dit onderzoek zijn

aan
Raad voor de Luchtvaart
ter attentie van
de heer F. Ehrhart

ons kenmerk
VH/3661

datum

18 DEC. 1998



vermeld in Appendix B. Hieruit bleek dat enkele definities van positieve richtingen, zoals door Transavia gemeld, niet correct waren, met name die van de stuurkolom en van het voetenstuur. Tevens bleek duidelijk een bepaalde tijdsvertraging aanwezig te zijn tussen de cockpit "input" en de roeruitslag als "output". Door deze tijdsvertraging kon er op het moment van landen geen grote hoogteroeruitslag worden waargenomen, terwijl er wel een grote stuurkolomuitslag werd gegeven. Met inachtneming van de gecorrigeerde tekenafpraak blijkt dat de laatste stuurkolomuitslag naar voren was (d.i. "nose down"). Met de tijdsvertraging in acht genomen zou dit 2 seconden later een grote uitslag van het hoogteroer hebben betekend van ca. 20 graden ("nose down"). Hoewel er op dat moment geen gegevens meer zijn, kan hierin de verklaring gelegen zijn van een snelle neusstandsverandering in neerwaartse richting, waarbij het neuswiel beschadigd kon worden.

5. Vliegtoestand op het moment van landen

Op een hoogte van ca. 100 ft werd de autopilot ontkoppeld, terwijl deze al bezig was een "decrab" uit te voeren door het geven van voetenstuur. Deze ontkoppeling resulteerde in een gierbeweging naar rechts van ongeveer 5 graden. Op het moment van landen was de neus nog niet opgelijnd met de baan: het verschil bedroeg ca. 8 graden. Ook was er nog een drift aanwezig (niet in de figuren gegeven). De neus is zich nog aan het omhoog bewegen, wat reden kon zijn geweest van de grote hoogteroeruitslag naar beneden. Uit de gemeten versnellingen en de rolhoek kan afgeleid worden dat de landing plaatsvond met het rechter hoofdwiel, met een landingsstoot van 2.1g. De daalsnelheid op dat moment was inmiddels afgenomen tot ca. 200 ft/min. Op het moment van "touchdown" was het vliegtuig nog naar rechts aan het rollen, en wordt er op dat moment een bijna volle uitslag met het stuurwiel gedaan naar links (in de rolroeruitslag is, door de tijdsvertraging, deze "input" niet meer te zien).

6. Conclusies

Uit de resultaten komt het beeld naar voren van een vrij rustige nadering, met veel wind. Zeker in het eerste deel van de nadering bedroeg deze ca. 70 kts, om vervolgens af te nemen tot ca. 40 kts op het moment van landing. Het turbulentieniveau lag niet erg hoog. Op lage hoogte kromp de wind niet, zoals meestal het geval is, integendeel: de wind ruimde juist iets, en kwam nog meer dwars te staan op de landingsrichting. Opvallend is het grote verschil in windsnelheid tussen enerzijds de door de B757 berekende wind en anderzijds de 3-D methode die het NLR gebruikt. Eén en ander resulteerde in een volgens het NLR te optimistische dwarswindschatting. Op het allerlaatste moment wordt, na de landing, een grote stuurkolomuitslag naar voren gegeven, kennelijk om de nog omhoog gaande standhoek te verkleinen, en om het neuswiel op de grond te krijgen. De windvariaties rondom het moment van landen waren in de orde van 10 kts.

Gezien de oorspronkelijke vraagstelling kan windshear als oorzaak van het ongeval, worden uitgesloten.

Mocht er, naar aanleiding van het voorafgaande, behoefte zijn aan een nadere toelichting dan zijn wij gaarne bereid deze te geven. Met deze brief beschouwen wij de door u verstrekte opdracht als beëindigd.

Hoogachtend,
Nationaal Lucht- en Ruimtevaartlaboratorium

Ir. F.J. ABBINK
Technisch Directeur

APPENDIX A

Lijst van figuren:

1. Wind speed
2. Wind direction
3. Headwind component
4. Crosswind component XWC
5. Vertical wind component
6. F-factor, F_{av}
7. Control column deflection
8. Control wheel deflection
9. Pedal deflection
10. Elevator surface deflection
11. Aileron surface deflection
12. Rudder surface deflection
13. Pitch angle
14. Pitch rate
15. Bank angle
16. Roll rate
17. Magnetic heading
18. Yaw rate
19. Longitudinal acceleration
20. Lateral acceleration
21. Vertical acceleration
22. Radio altitude
23. Vertical speed, or climb rate

ws.stg

— : NLR; - - - : 12" NLR; : 12" Meteo Rwy 19R

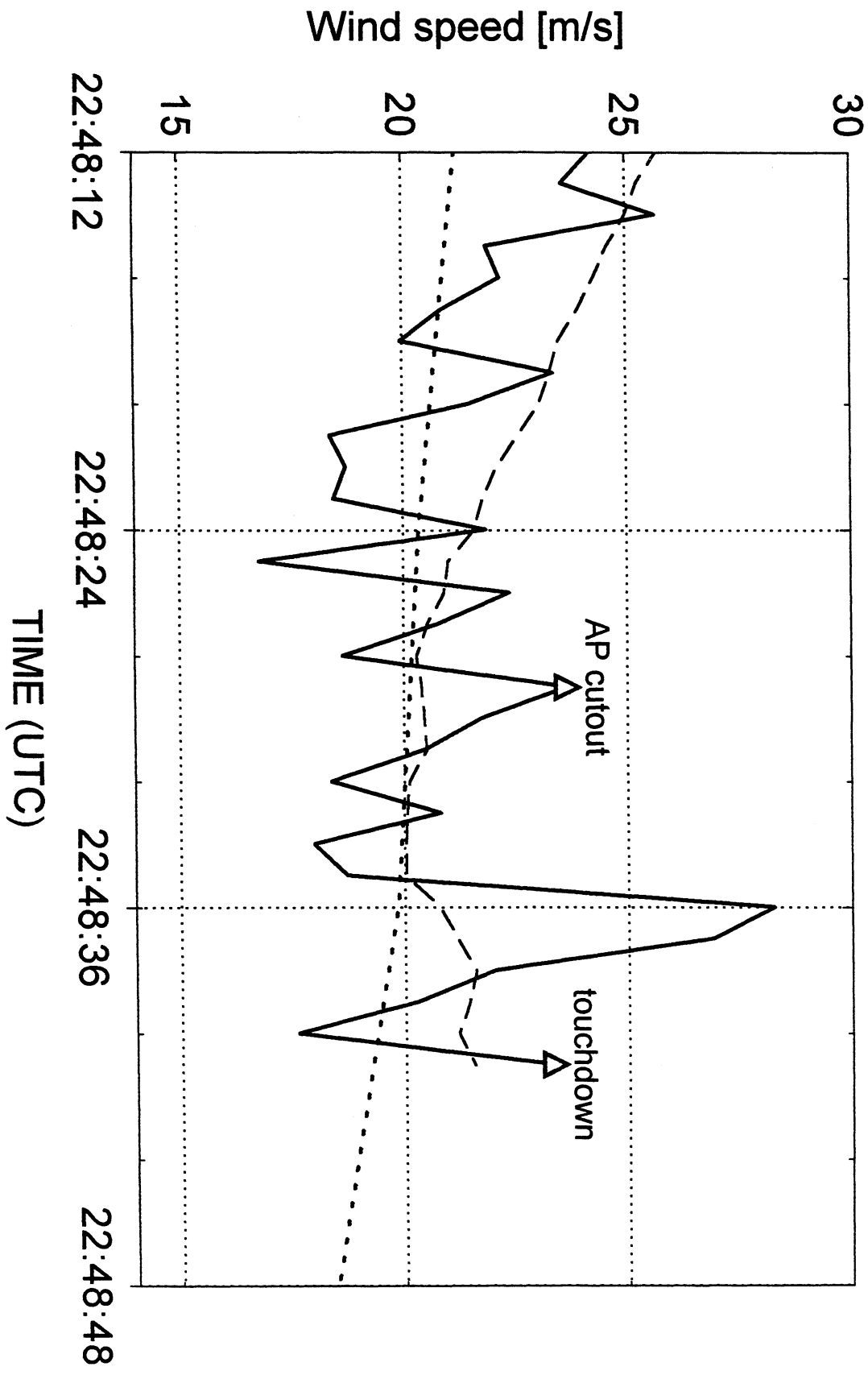

wdir.stg — NLR; - - - 12" NLR; 12" meteo Rwy 19R

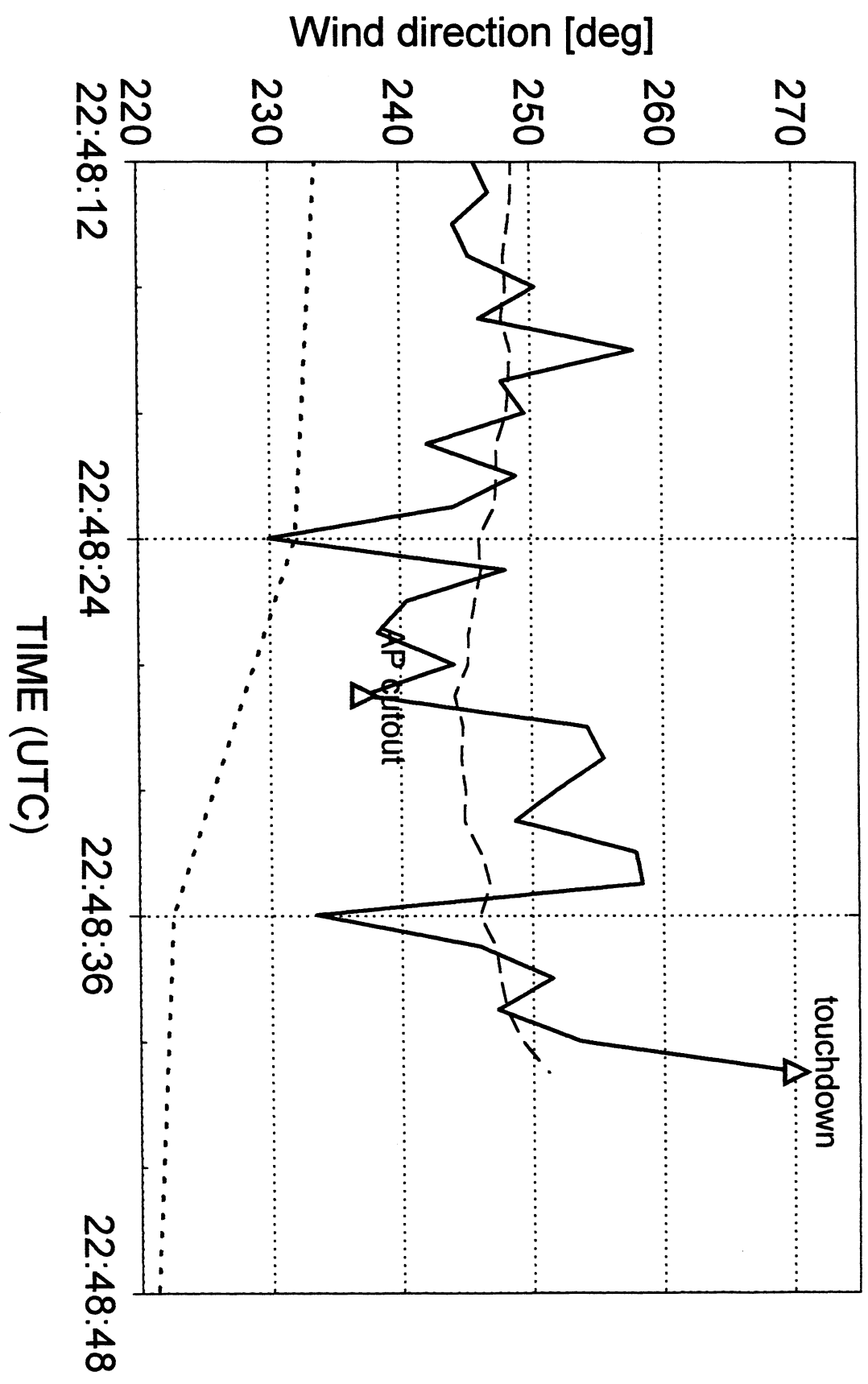

hwc.stg

--- NLR data; 12" meteo wind Rwy 19R

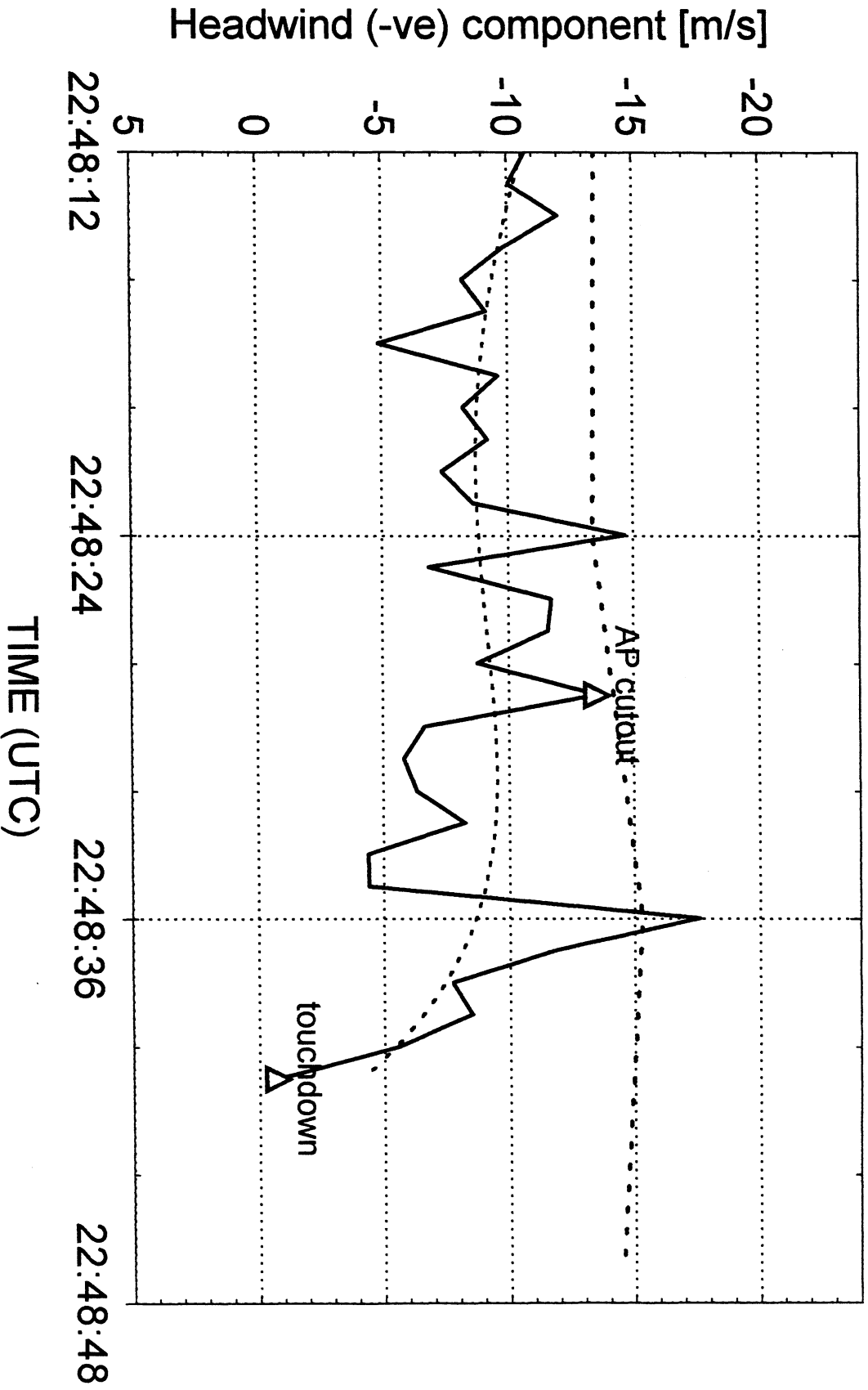

XWC (kts) (+ve: wind from right)

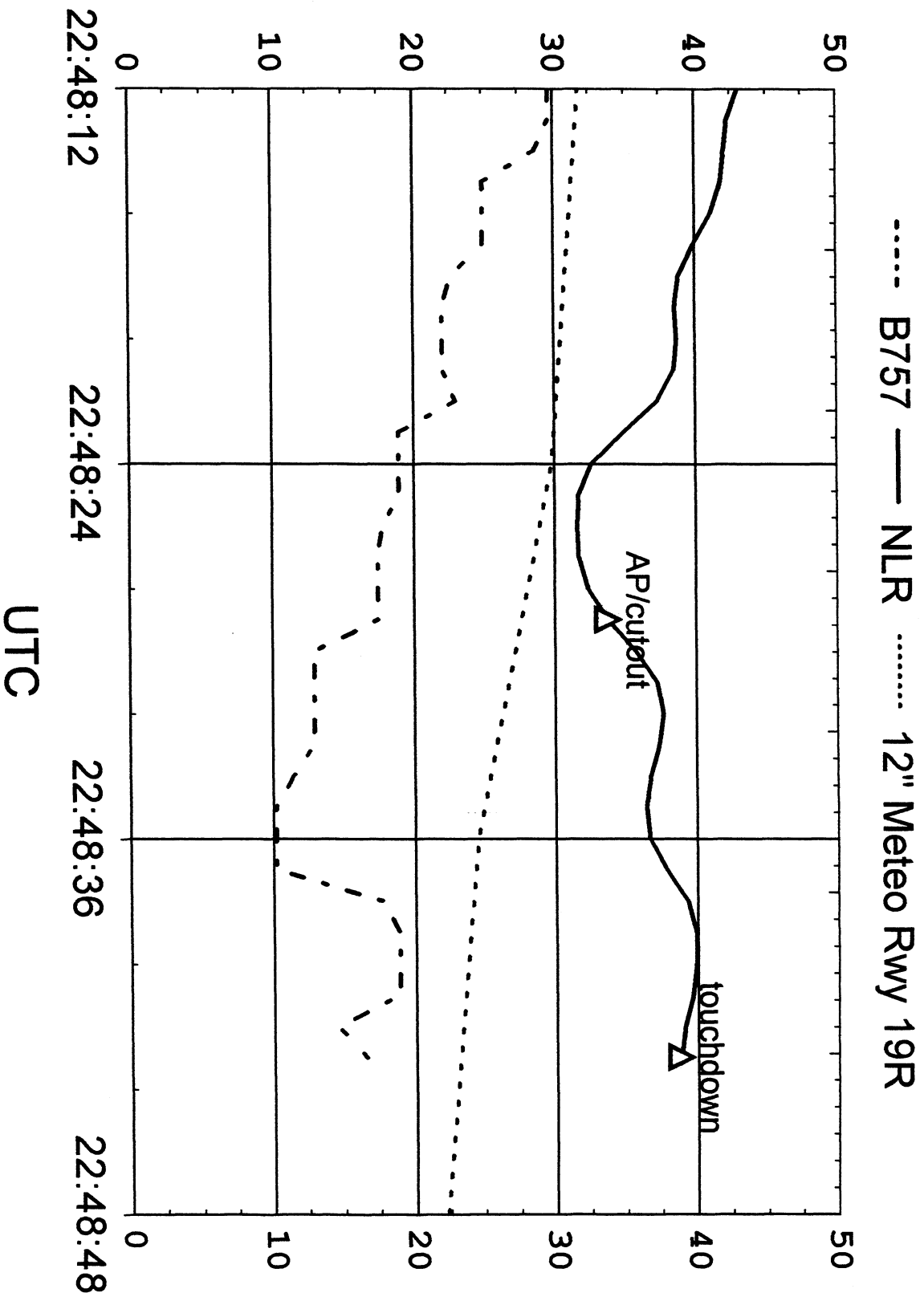

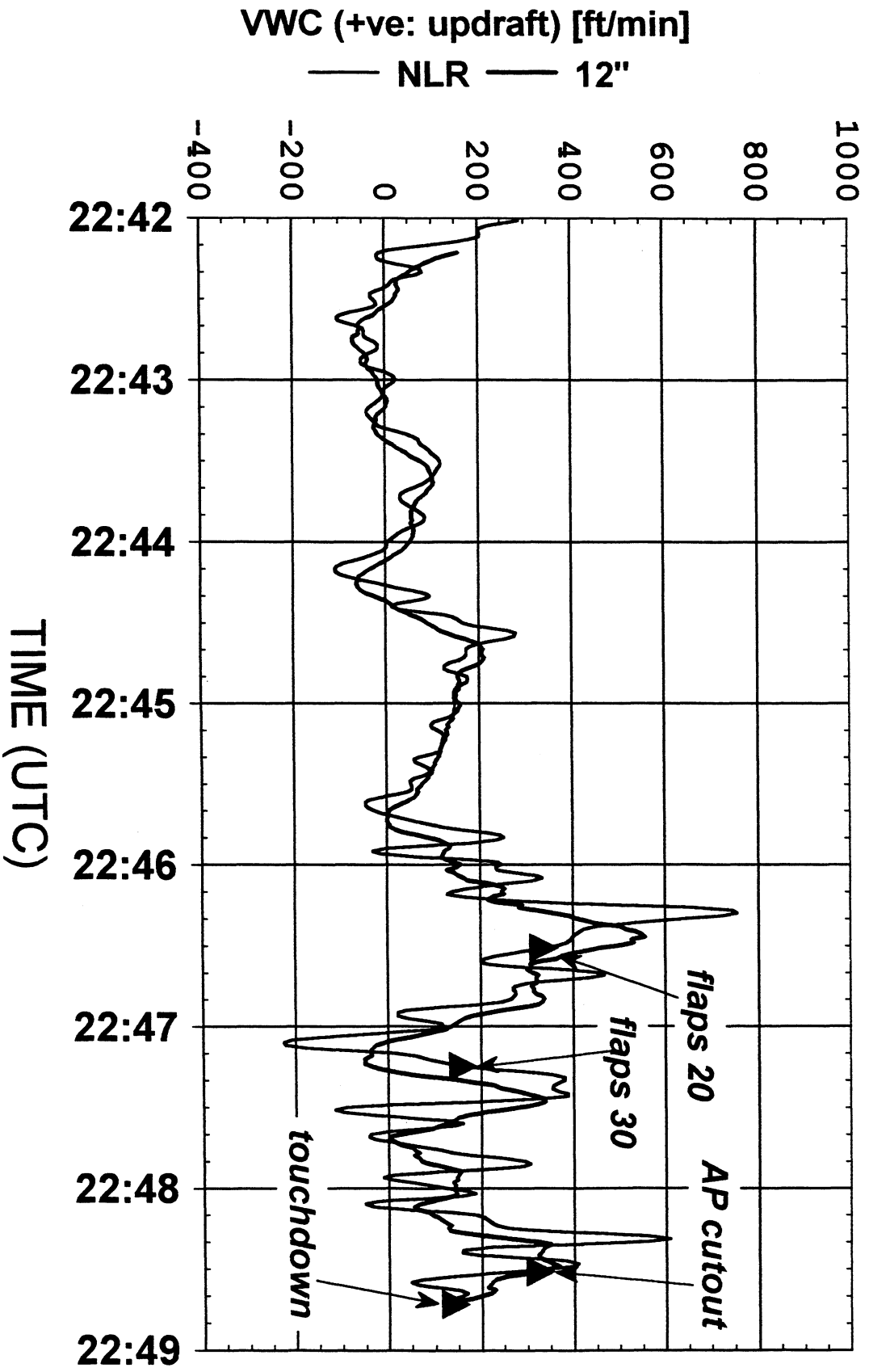

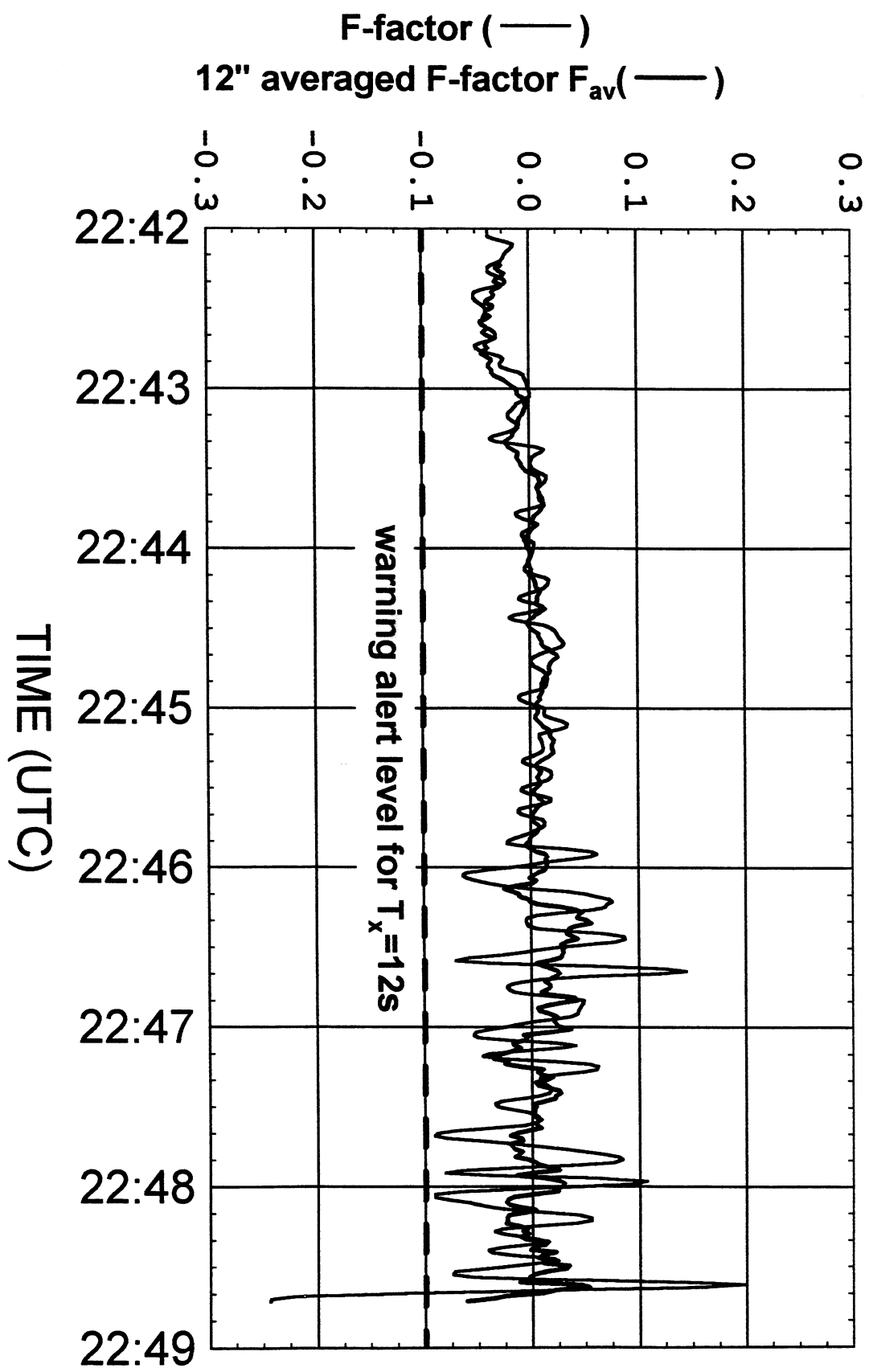

column.stg

— data; used in model prediction

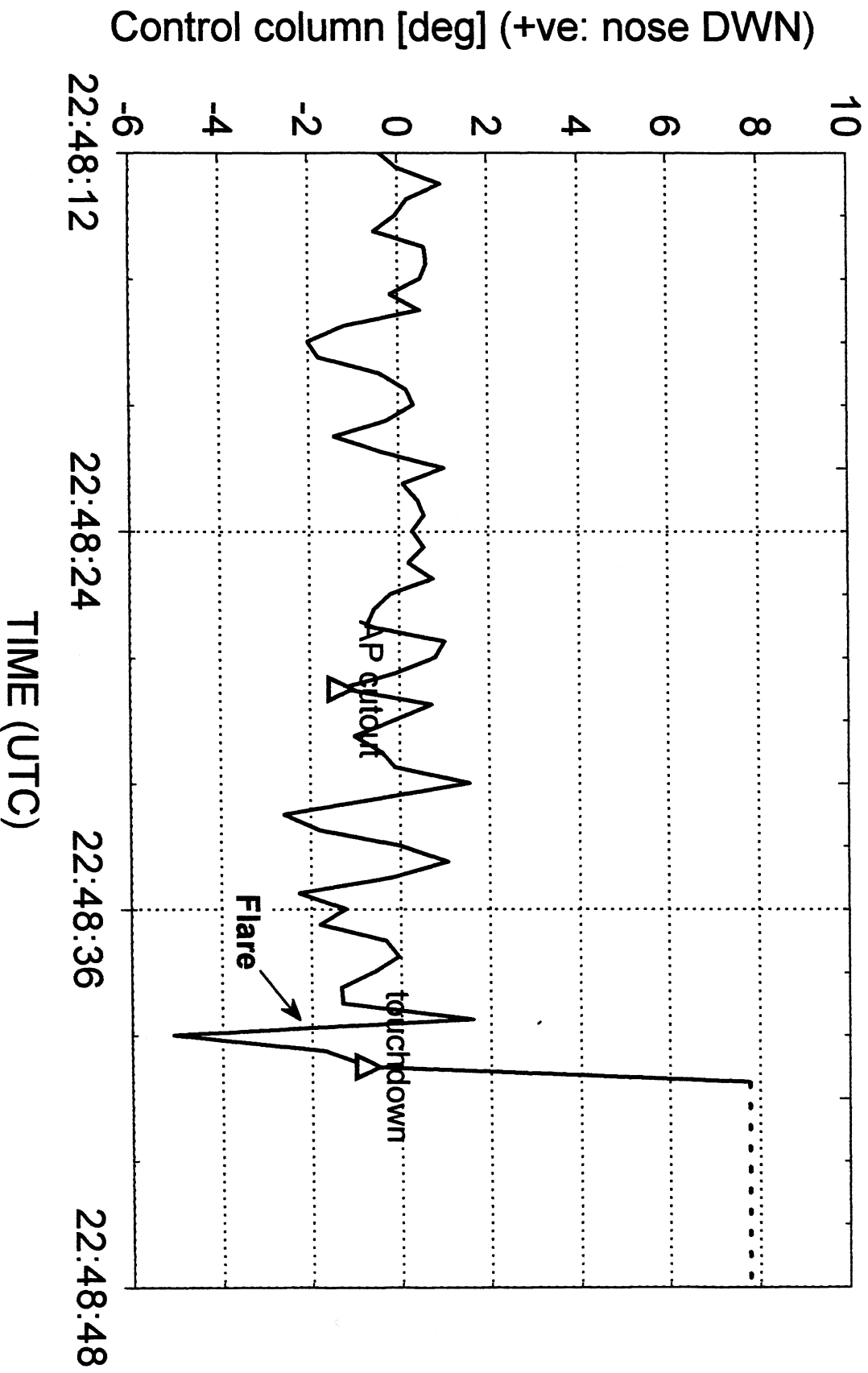

ctrlwhl.stg

Control wheel defl. [deg] (+ve: left rotation)

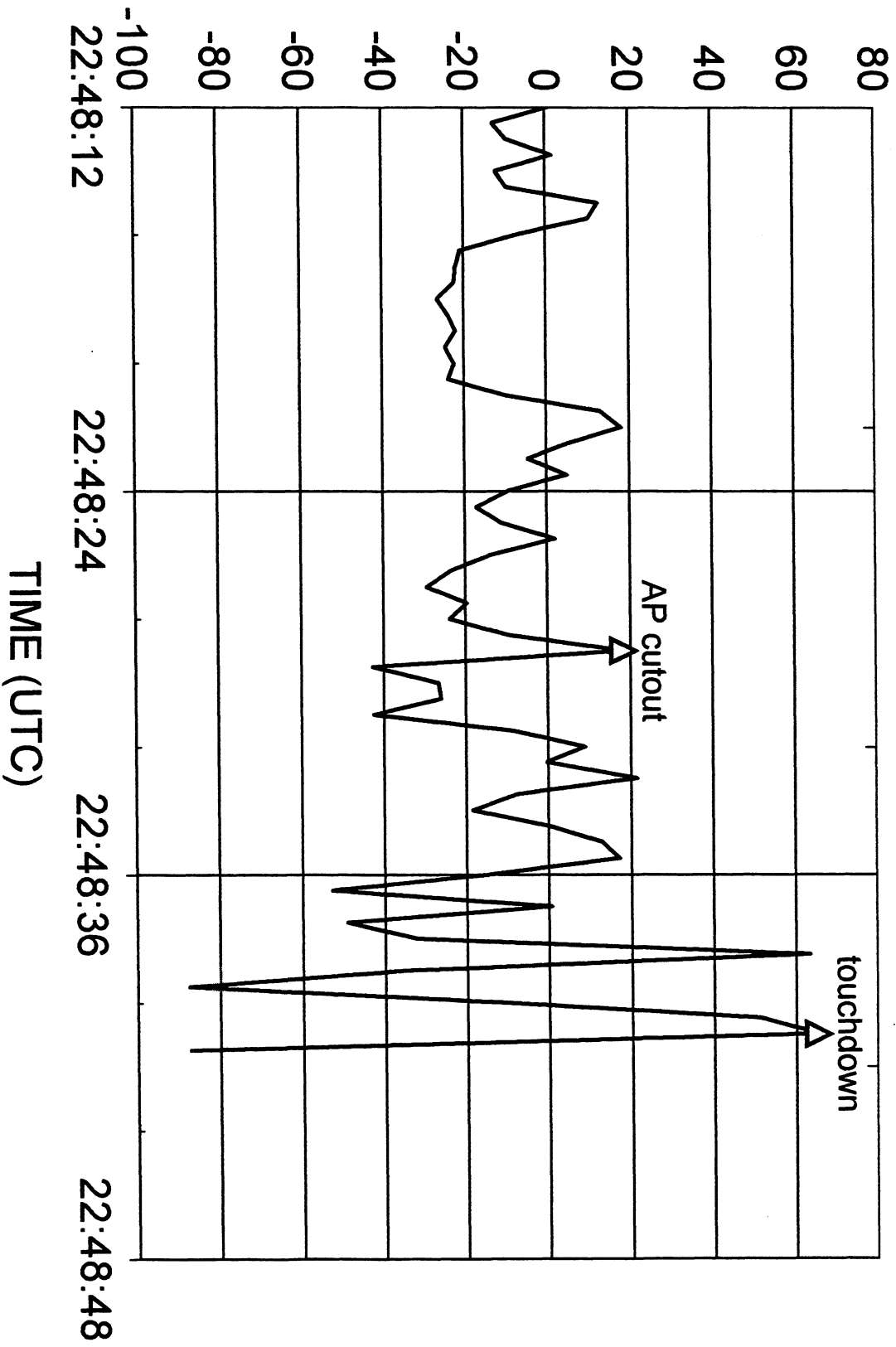

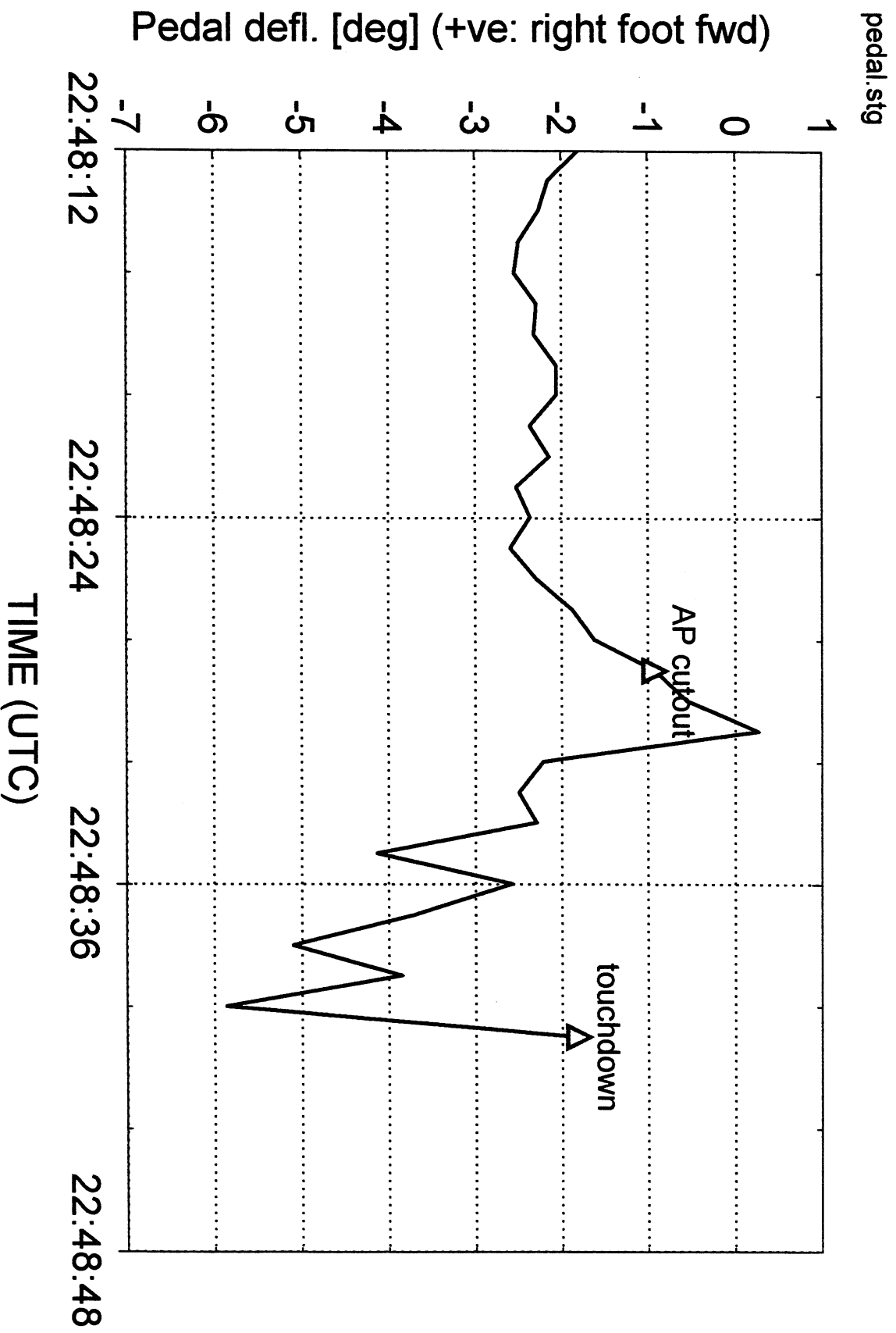

elmodel.stg

— data;

..... model;

..... predicted using model

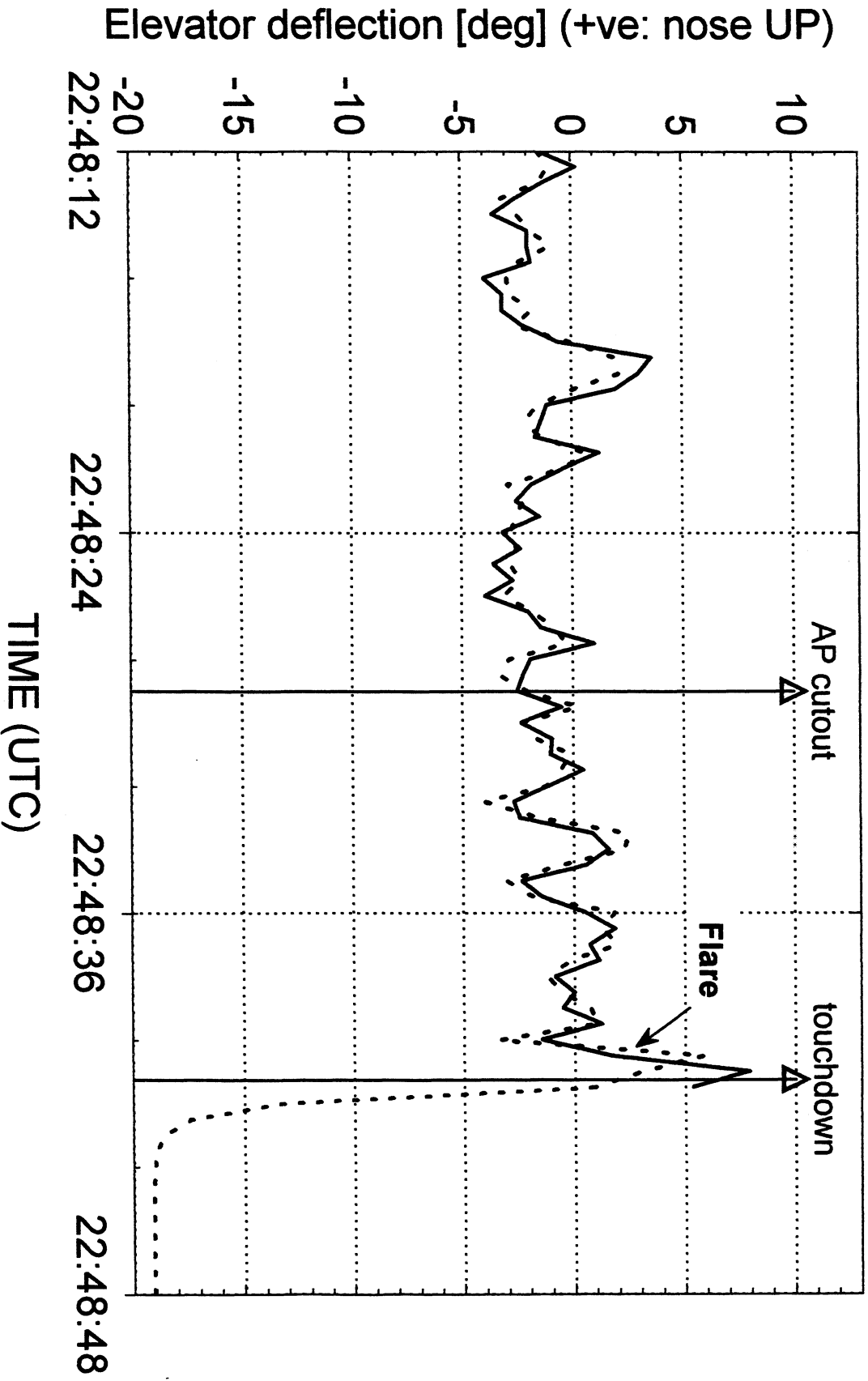

aileron.stg

Aileron defl. (deg) (+ve: right Aileron DWN)

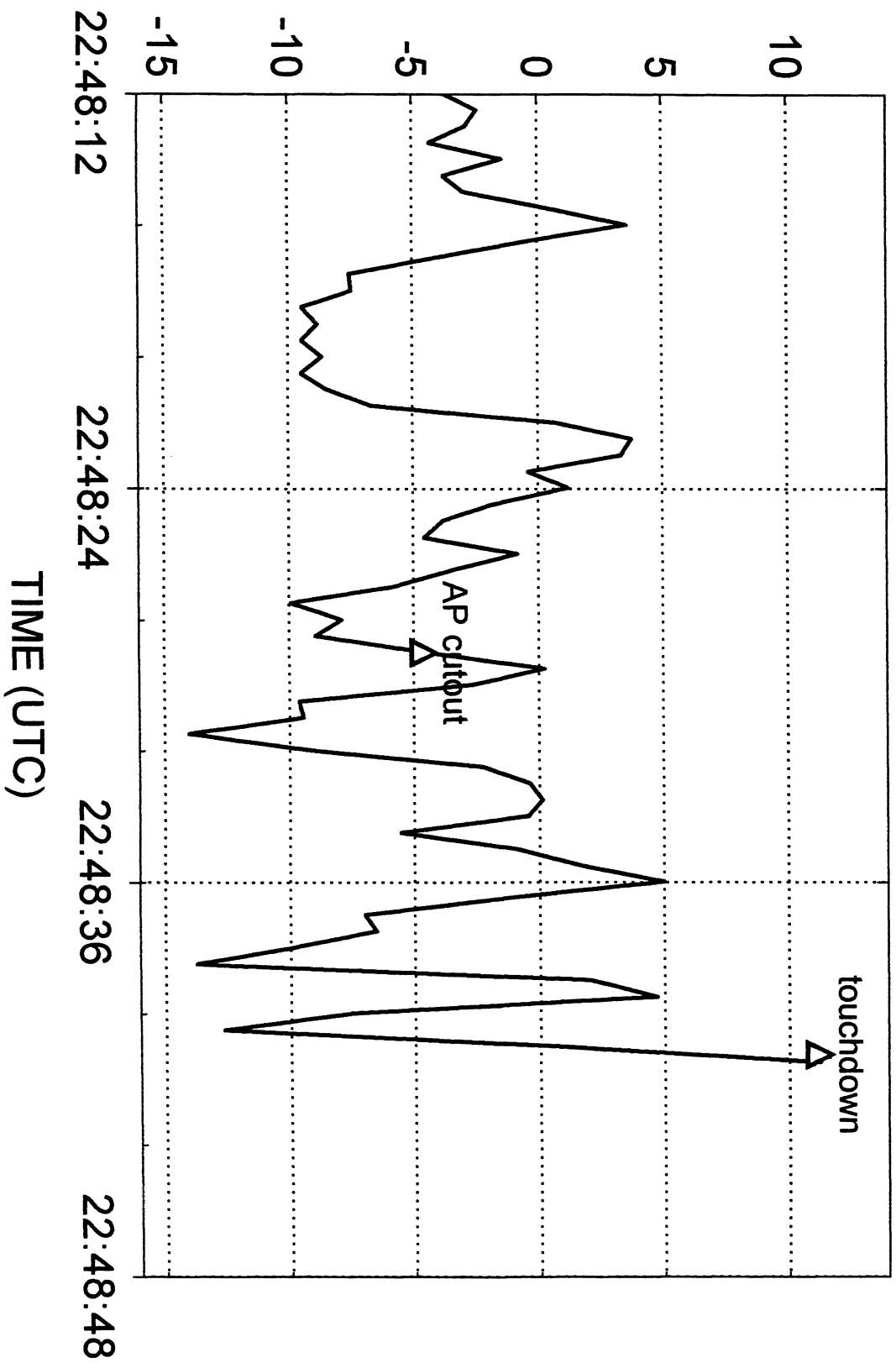

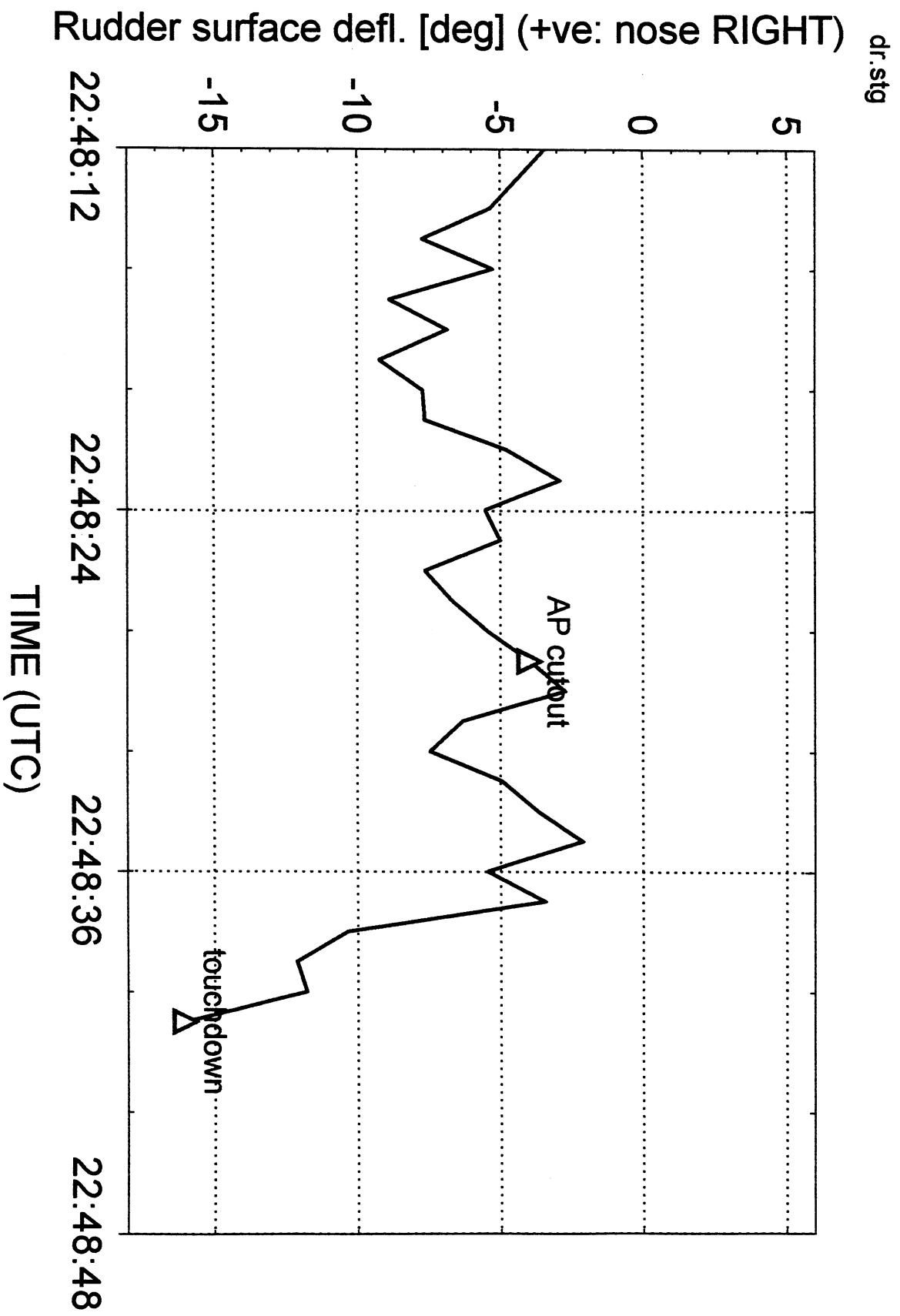

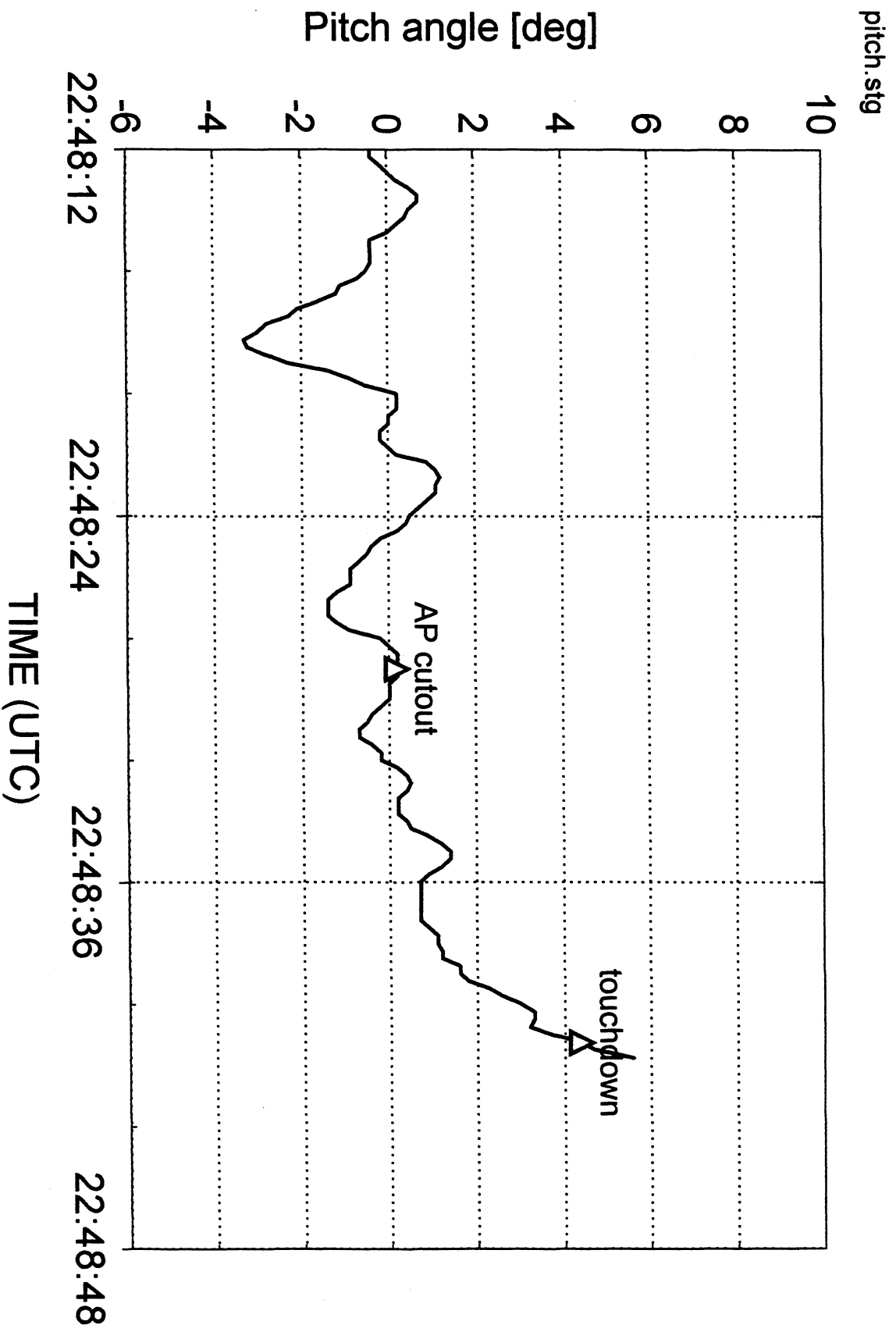

dieltd.stg

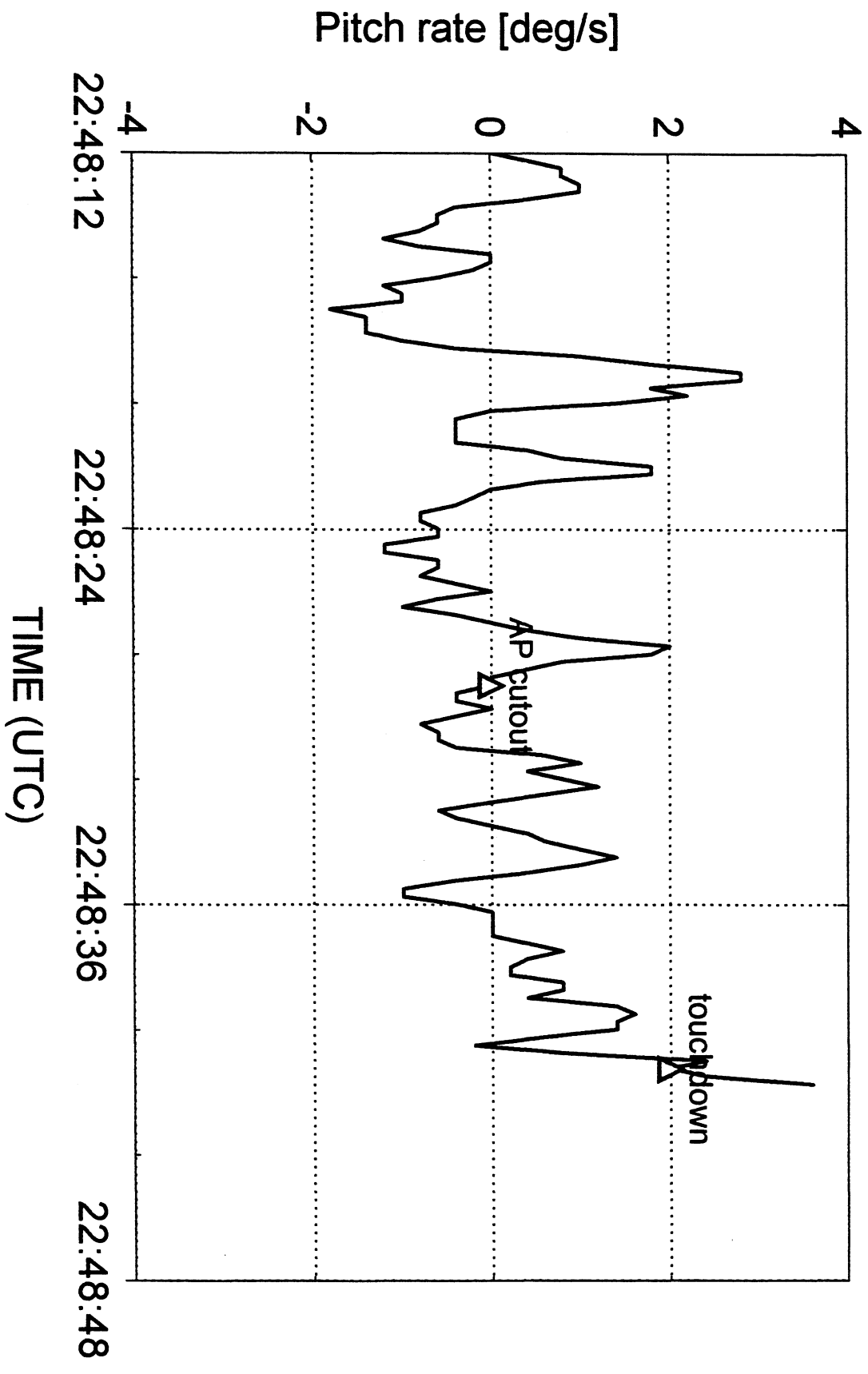

phi.stg

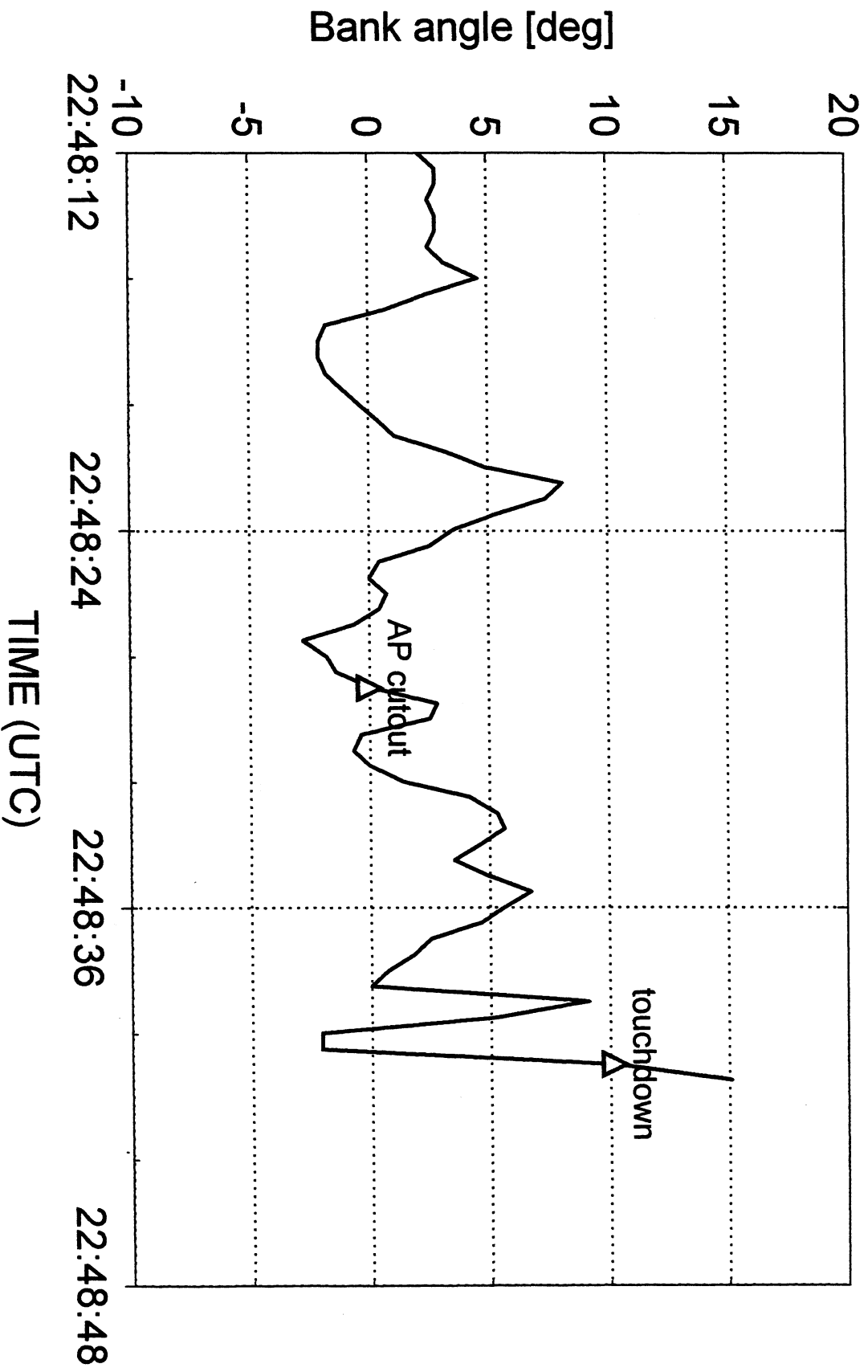

rollrate.stg

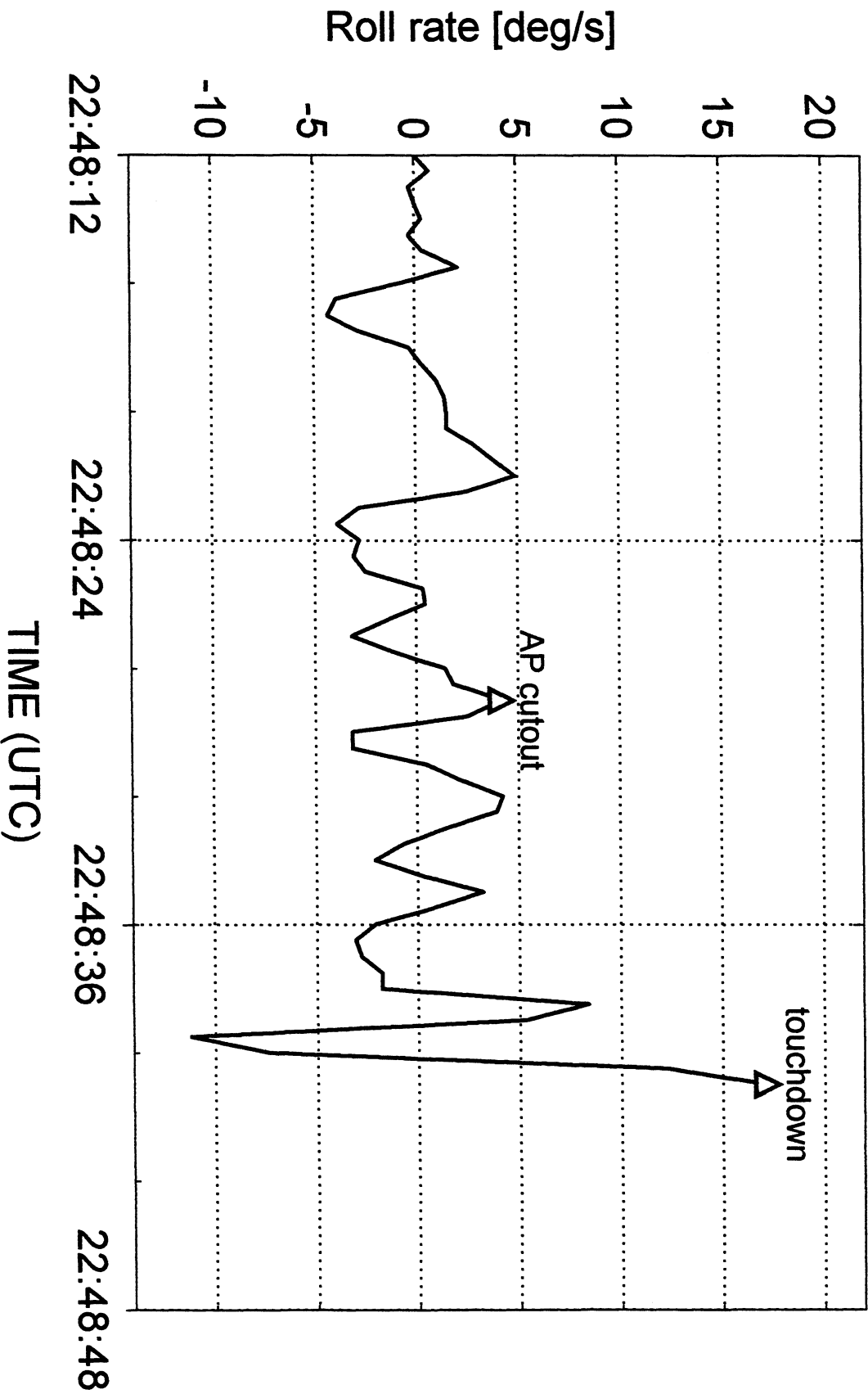

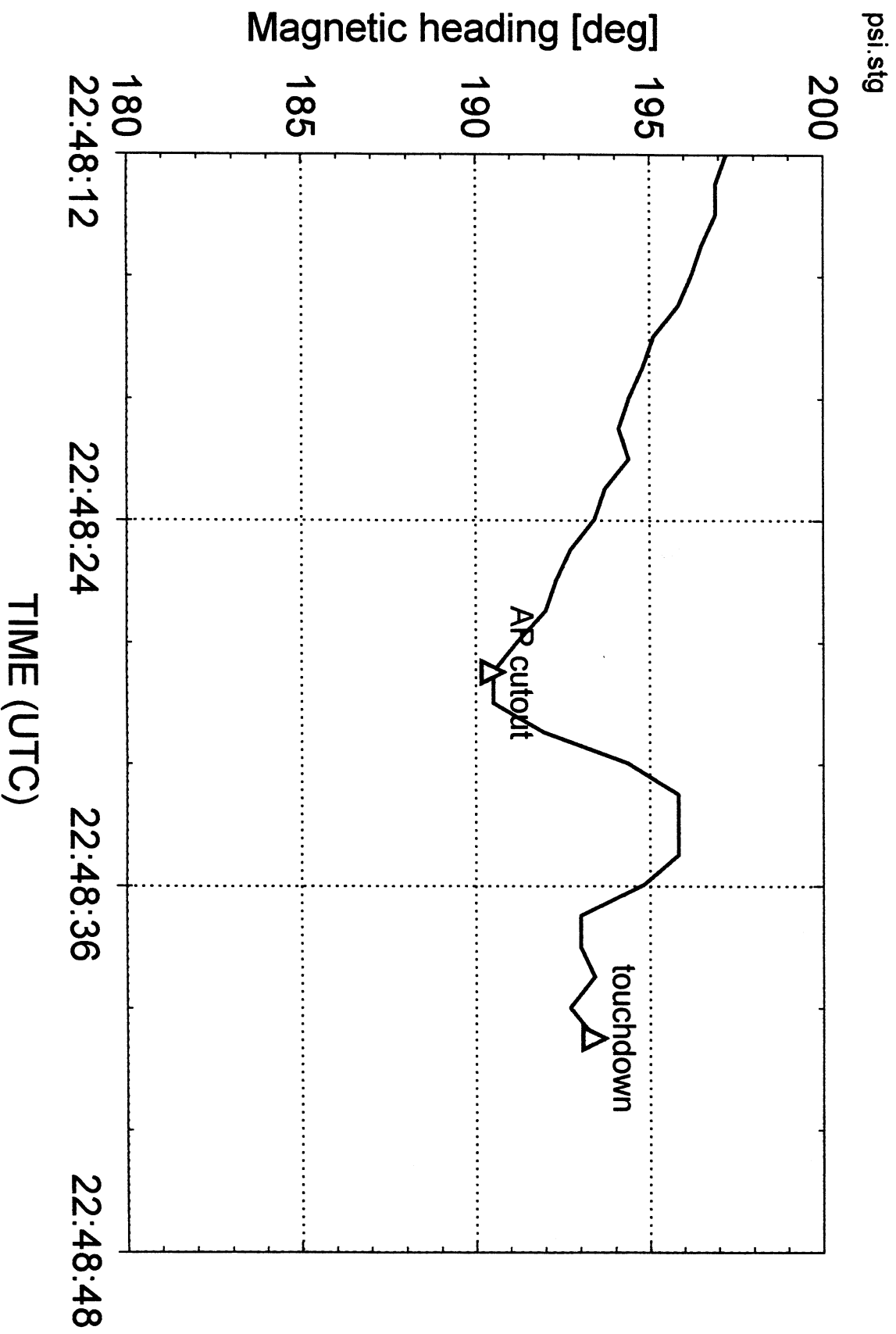

psidot.stg

Yaw rate [deg/s]

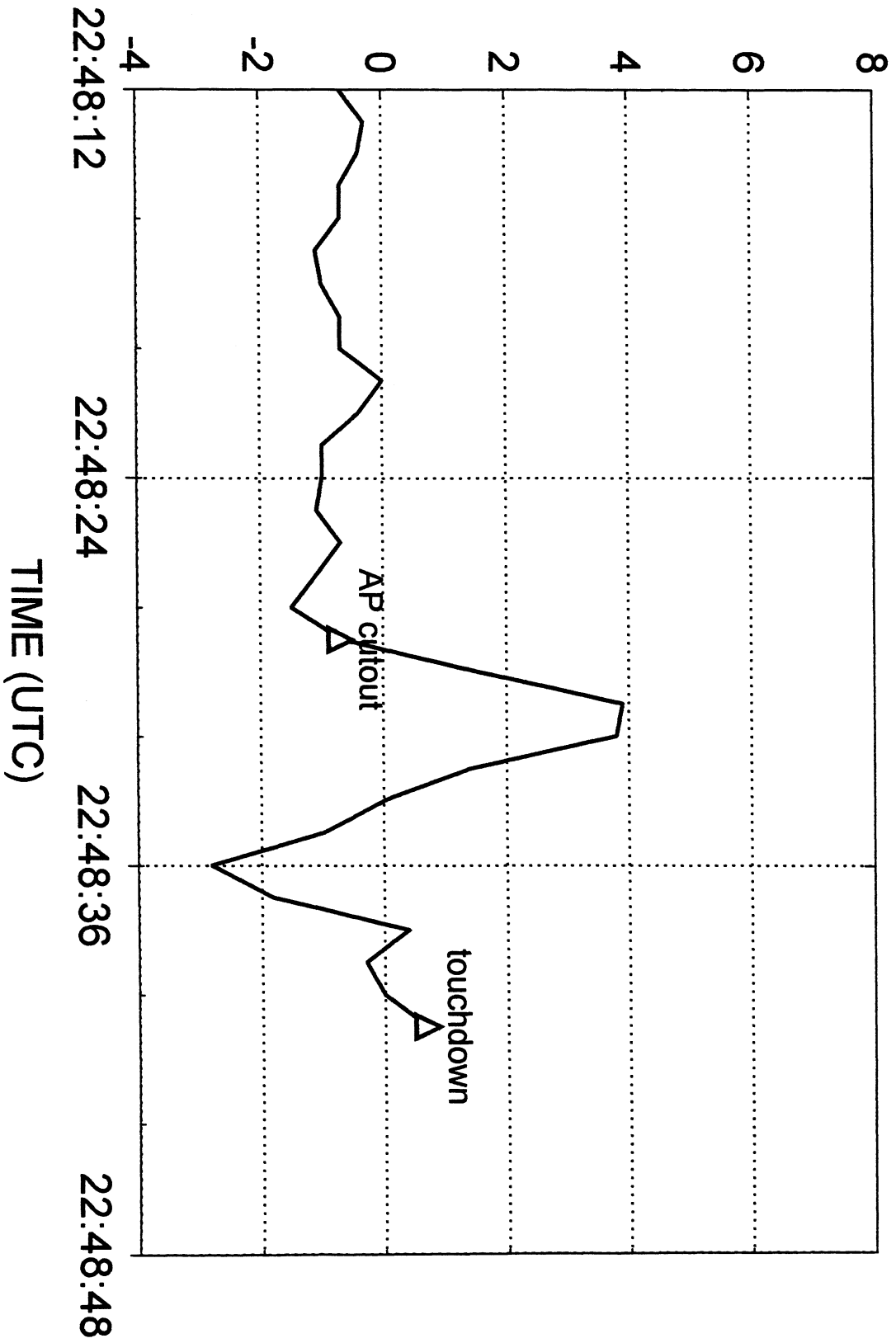

ax.stg

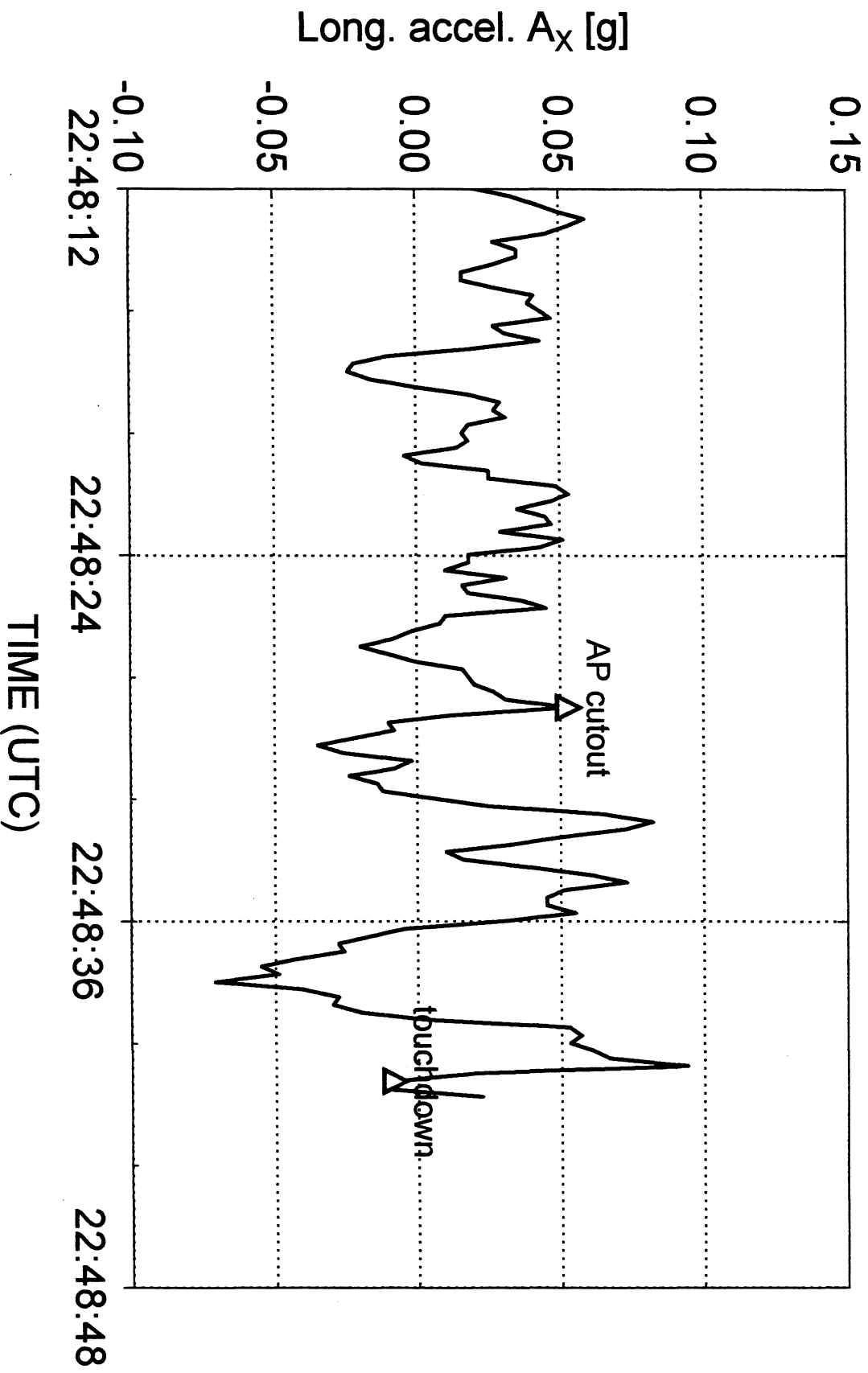

ay.stg

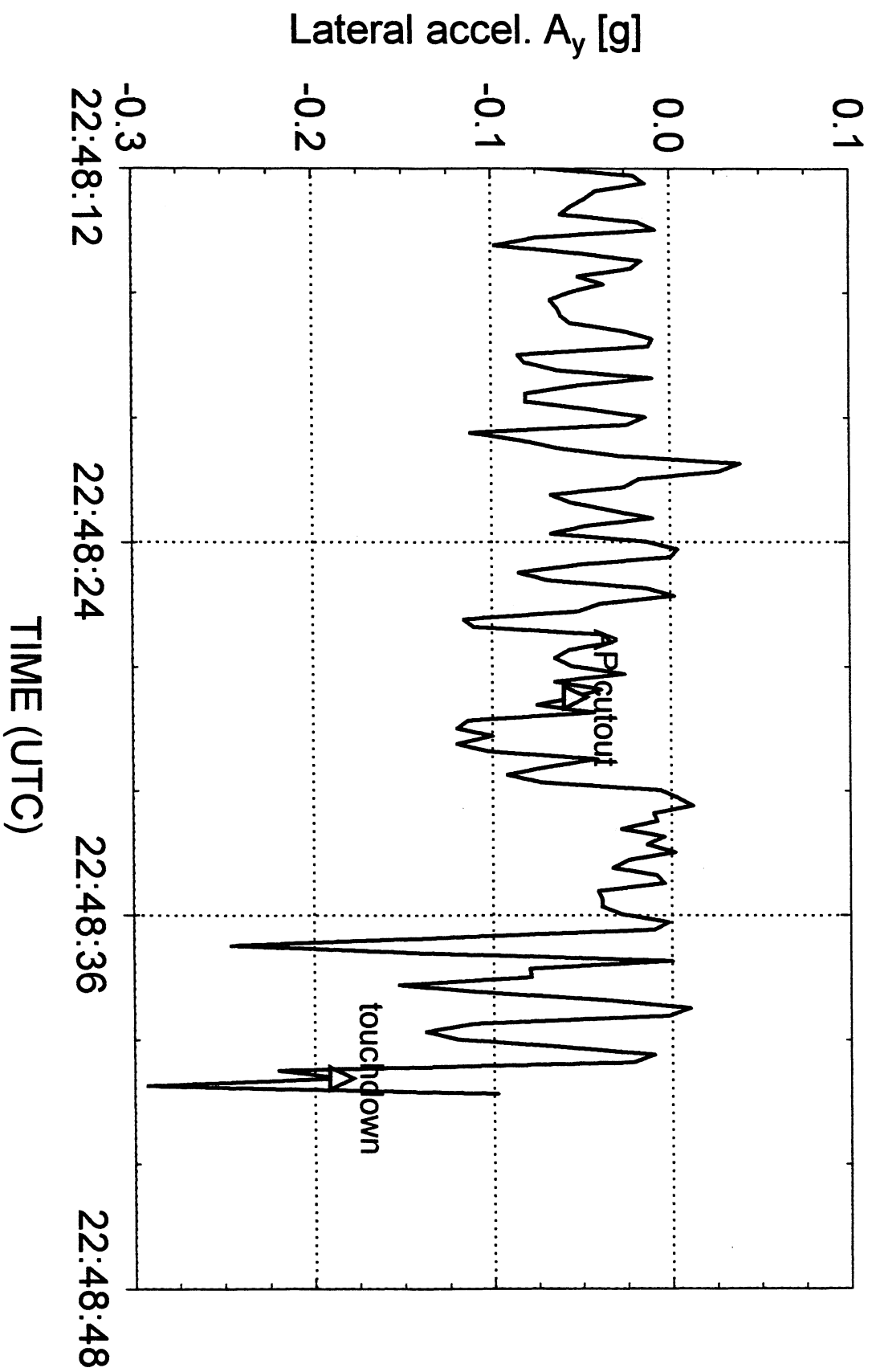

az.stg

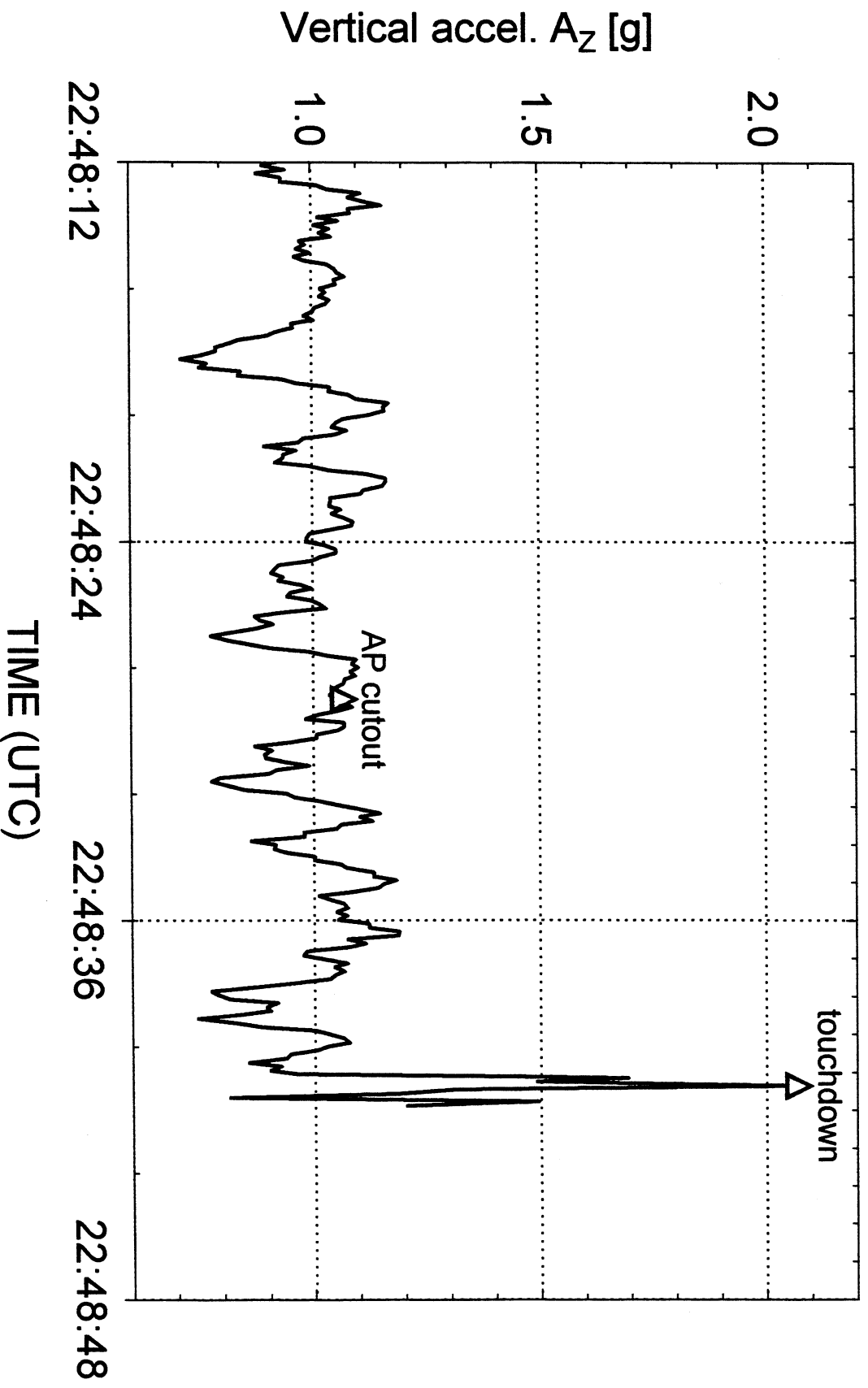

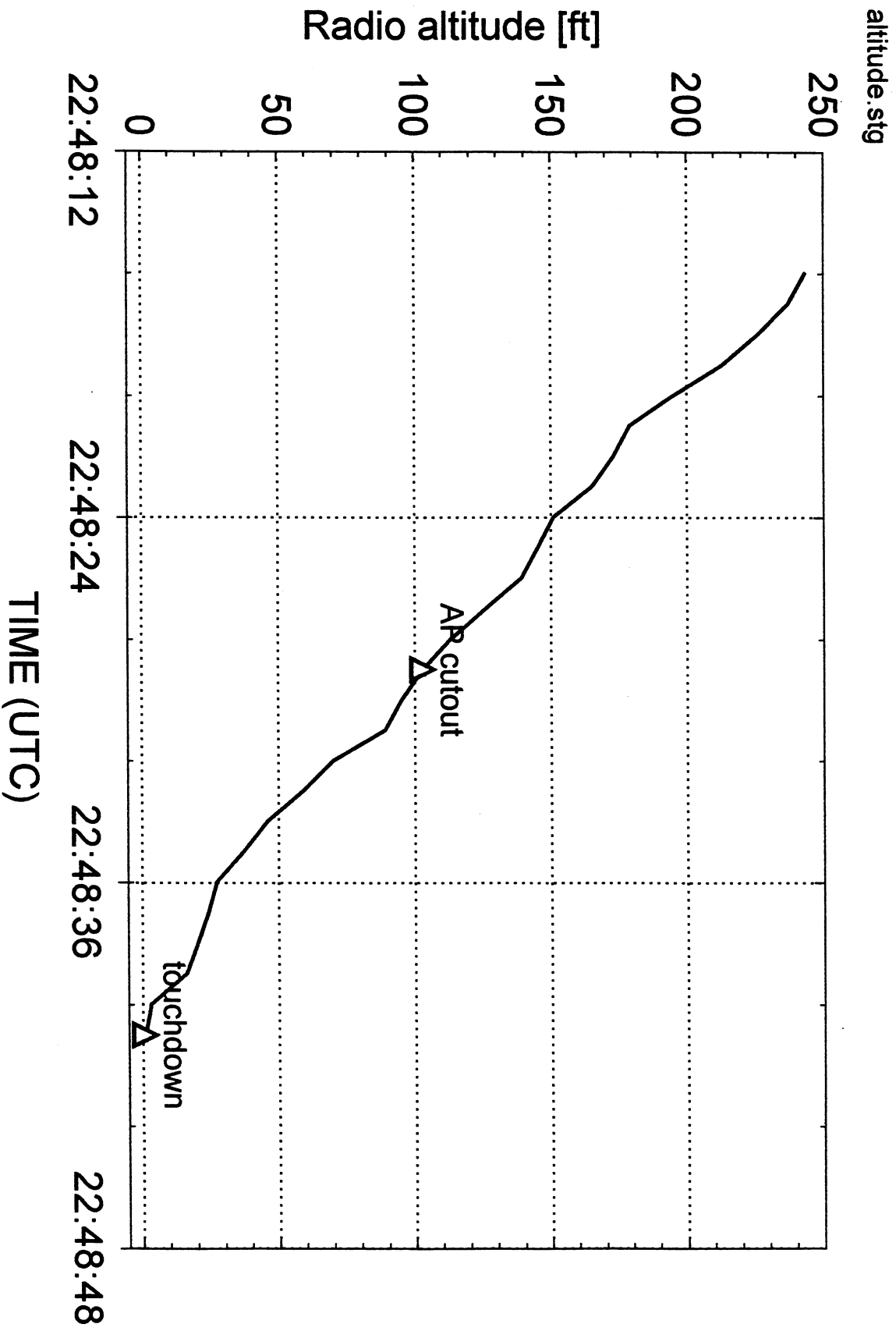

dhdt.sig

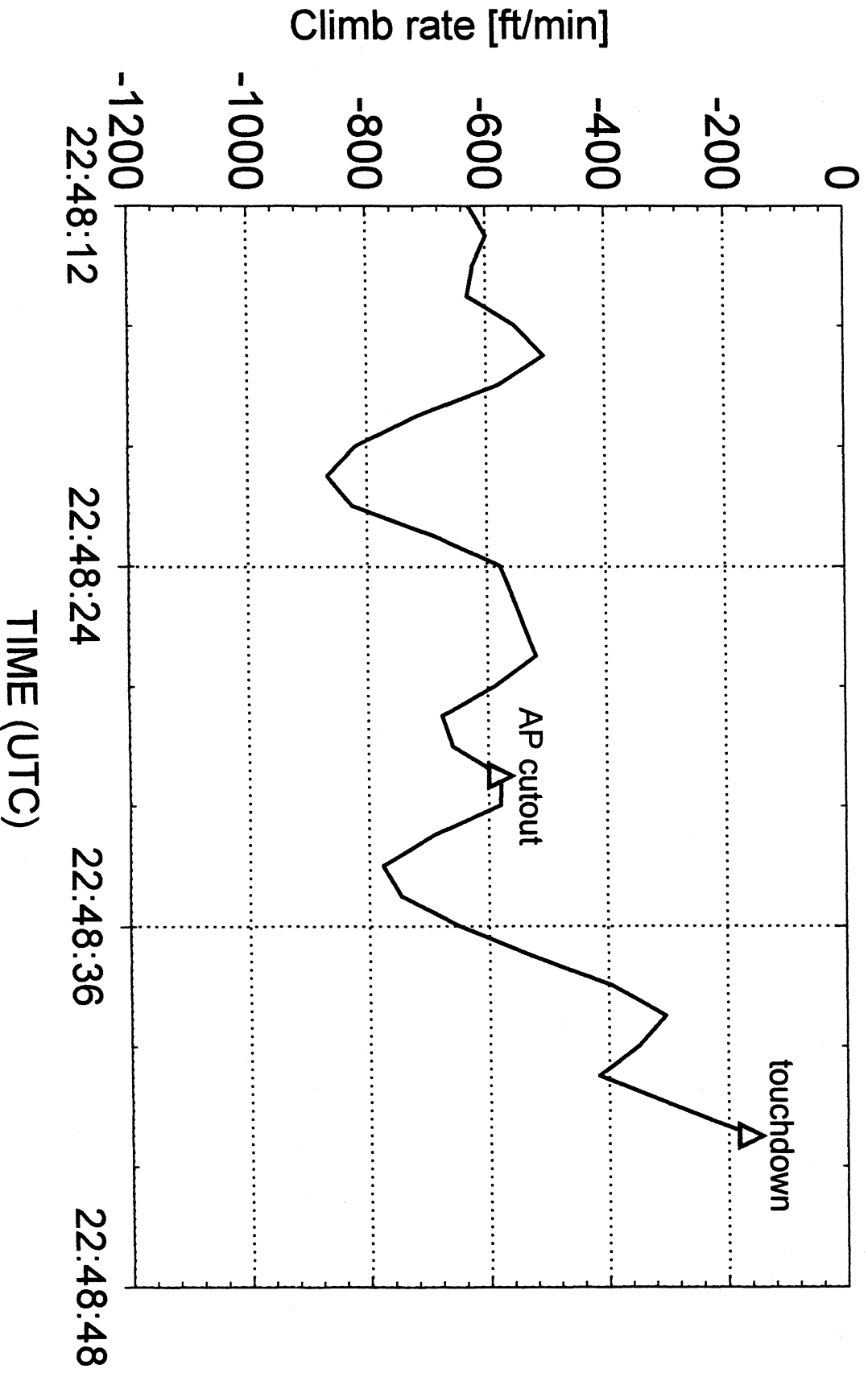

APPENDIX B

ANALYSIS OF FLIGHT DATA RECORDER DATA B757 TRANSAVIA PH-TKC CONTROL SYSTEM SIGN DEFINITION CORRECTIONS

By
H. Haverdings
National Aerospace Laboratory NLR
Amsterdam

December 2nd, 1998

1 Definitions

Definitions of control inputs (cockpit controls ‘column’, ‘wheel’ and ‘pedal’, and control surfaces ‘elevator’, ‘aileron’ and ‘rudder’) are given in Table 1. One set of definitions has been obtained from Transavia, the second set has been obtained from theory (stability theory has a “standard” set of definitions), the last set of definitions has been obtained from the flight data, after analysis has been performed, discussed in section 2.

Table 1 *Flight control system sign definitions*

Item		direction of travel	Sampling rate (1/s)	sign definition		
				Transavia	theory	data
cockpit controls	control column	aft	2	+	-	-
	control wheel	counter-clockwise	2	+	+	+
	pedal	left fwd	1	+	+	-
control surfaces	elevator-L(eft)	up	1	+	-	+
	elevator-R(ight)	up	1 (2)	+	-	+
	aileron-R	up	1 (2)	+	-	-
	aileron-L	up	1	+	+	+
	rudder	(nose) right	1	+	-	+

Generally the left and right aileron are linked together, such that the response of the left one is of opposite sign to the right aileron, hence the difference in sign convention in the theoretical case. Furthermore the left and right elevator are linked (they move together), but in the data they had separate sensors to measure their position. By sampling each at a spacing of half the sampling interval, a doubling of the sampling rate has been achieved (this also applies to the ailerons).

There are two ways of showing the correctness of the sign conventions:

- 1 using the (cor)relation between cockpit control and control surface deflection as it has been determined from fitting a hydraulic system between cockpit control input and control surface deflection, and
- 2 using the (cor)relation between control surface deflection and aircraft response (pitch rate, roll rate, yaw rate or sideslip angle).

2 Control system

Generally one should understand that a time delay exists between the response of the cockpit control and the corresponding control surface deflection. This is mainly due to the hydraulic system, as well as to other lags. The hydraulic system has been modeled as a first-order time delay, for which the general differential equation is:

$$\tau \frac{d\delta_s(t)}{dt} + \delta_s(t) = K \cdot [\delta_c(t) + \text{bias}] \quad \text{Eq. (1)}$$

Here δ_s is the control surface deflection *output* at time t , δ_c is the corresponding cockpit control *input*, K is the gain between cockpit-to-surface control deflection, and ‘bias’ is a bias correction, to compensate for zero drifts, etc. When $K > 0$ then a positive cockpit control yields

a positive control surface deflection, and vice-versa. The sign of the control gain thus can be used to check the sign definitions given in Table 1.

Equation (1) has been discretized using the sample time step Δt (which can be 0.5s or 1.0s, i.e. the reverse of the sampling rate), which yields the following discrete equation:

$$\delta_s(i+1) = e^{-\Delta t/\tau} \cdot \delta_s(i) + (1 - e^{-\Delta t/\tau})K \cdot [\delta_c(i) + \text{bias}] \quad \text{Eq. (2)}$$

Here $\delta_s(i)$ means the control surface deflection at time t_i . This equation, for each control axis, was used to perform a regression of $\delta_s(i)$ and $\delta_c(i)$ on $\delta_s(i+1)$. The regression yields values, from which the time lag τ , the gain K and the bias can be determined, which give the best fit of the model to the data.

When performing the regressions mentioned above, the results for each corresponding control axis are as given in Table 2.

Table 2 *Identified control system lags, gains and biases*

Control axis	Time lag τ	Gain K	Bias
Long. (pitch)	0.40	-2.23	0.778
Lateral (roll)	0.79	0.359	-0.036
Directional (yaw)	1.05	2.734	0.105

To show how such a fit looks like, the output from the longitudinal hydraulic model, i.e. the elevator control surface deflection, computed using the control column as input into the hydraulic system, has been plotted in Figure 1, together with the measured elevator deflection. For only the last 30 seconds shown, the overall good quality of the fit is obvious!

2 Correlations

2.1 Longitudinal control

2.1.1 Control column - elevator

The associated control system parameters identified from flight data are given in Table 2. As the gain is negative this implies that a *positive* cockpit control results in a *negative* surface deflection, or vice-versa. This agrees with the theoretical sign convention, but does not match with Transavia's definition. Either their sign definition of the control column, or of the elevator, is wrong. Which way is which can only be determined after checking the correlation between the elevator surface deflection and the pitch rate response.

2.1.2 Elevator – pitch rate response

Again here it is reminded that a time lag generally exists between elevator input and the pitch rate response. When taking pitch acceleration instead then there should be no lag, at the expense of deriving the pitch acceleration from differentiating the pitch angle twice, which produces more noise in the signal.

A cross-correlation between the elevator input and the pitch rate/pitch acceleration response shows that at a lag of 0s the correlation coefficient is 0.5-0.6 for the pitch rate, and about 0.3-0.4 for the pitch acceleration. This implies that a *positive* elevator input results in a *positive* pitch rate, i.e. a nose-up pitch rate. This can only be the result of an *upward* elevator input, i.e. a positive elevator input. However, in view of the negative gain in the control system the

2.2 Lateral control

2.2.1 Control wheel – aileron

For the aileron hydraulic system the definition of “total average aileron” δ_a is used, where

$$\delta_a = -(\delta_{a,R} - \delta_{a,L})/2 \quad \text{Eq. (3)}$$

Here the aileron surface deflection δ_a has as sign convention: positive = right aileron down/left aileron up (i.e. inducing a left roll). It should therefore correlate with the control wheel turning counter-clockwise (positive).

The gain in the control system is positive, see Table 2. This means that at least the ratios of the sign definitions of Transavia are good.

2.2.2 Aileron – roll rate response

The correlation between roll rate and aileron was determined, including a lag of 1 between aileron deflection and roll rate. The correlation turned out to be -0.604 , i.e. a *positive* (right) aileron (down) deflection gives a *negative* roll rate (left roll). This corresponds with the sign definition of Transavia given in Table 1.

2.3 Directional control

2.3.1 Pedal – rudder

The correlation between rudder pedal and rudder deflection is positive ($K > 0$), see Table 2. From Transavia’s sign definitions of the rudder deflection (+=right) and rudder pedal (+ = left foot forward) a negative correlation should exist for compatibility. As this correlation is positive, there is an error in Transavia’s definition, either in that for the rudder pedal or for the rudder deflection.

2.3.2 Rudder – yaw rate/sideslip angle response

It turned out that sideslip angle was a much better parameter to use than yaw rate or yaw acceleration due to the relative size of the response. A positive sideslip angle can only be achieved by a rudder deflection to the left, i.e. left-foot forward. The data showed there was a negative correlation (-0.28) between sideslip angle and rudder deflection. A scatter plot, showing this correlation, is given in Figure 2. In other words, a *negative* (i.e. left) rudder surface deflection corresponds to a *positive* sideslip angle. However, due to the positive gain, a negative rudder deflection should then also mean a negative rudder pedal deflection, i.e. right-foot forward, when adhering to Transavia’s definition. This is wrong. The proper definitions are given in Table 1, last column.

3 Summary of definitions

From the previous chapters one can summarize that some definitions given by Transavia are wrong. The definitions by Transavia that need correction are shaded grey in Table 1. The important implication of this correction has to do with the pilot input during the flare, and after touchdown, as discussed in the next section.

4 Elevator surface deflection prediction during landing

When predicting the elevator surface deflection during flare and landing, it is assumed that the control column input is frozen at the last moment in time where data is available. The control column input, from just before Autopilot cutout to 2 seconds after touchdown is shown in Figure 3.

Using the longitudinal hydraulic control model, the predicted elevator surface deflection generated by the model is as indicated in Figure 4, together with the measured elevator surface deflection response. The associated aircraft pitch angle response is given in Figure 5. Apart from the fact that the predicted elevator response matches the measured one very well, one can see the large negative (predicted) elevator response after touchdown, i.e. in a nose-down sense. Within 2 seconds from touchdown the elevator is predicted to move to about 19 degrees nose-down position. With such a fast and large input, while at the same time the pitch angle was still increasing, a quick and strong nose-down response can be expected. It is likely that this large nose-down pitch input was given due to the fact that at touchdown the pitch angle still tended to increase.

5 Concluding remarks

From inspection and analysis of the flight data it appeared that the definition for positive control column input was wrong. The implication of this is that at and just after touchdown, with the corrected sign definition it becomes possible to explain the possibility for a large negative pitch rate, with associated risk of a hard nosewheel landing. Due to the time lag between column input and elevator response the elevator response data got lost, but the use of the hydraulic model made it possible to “reconstruct” the elevator response.

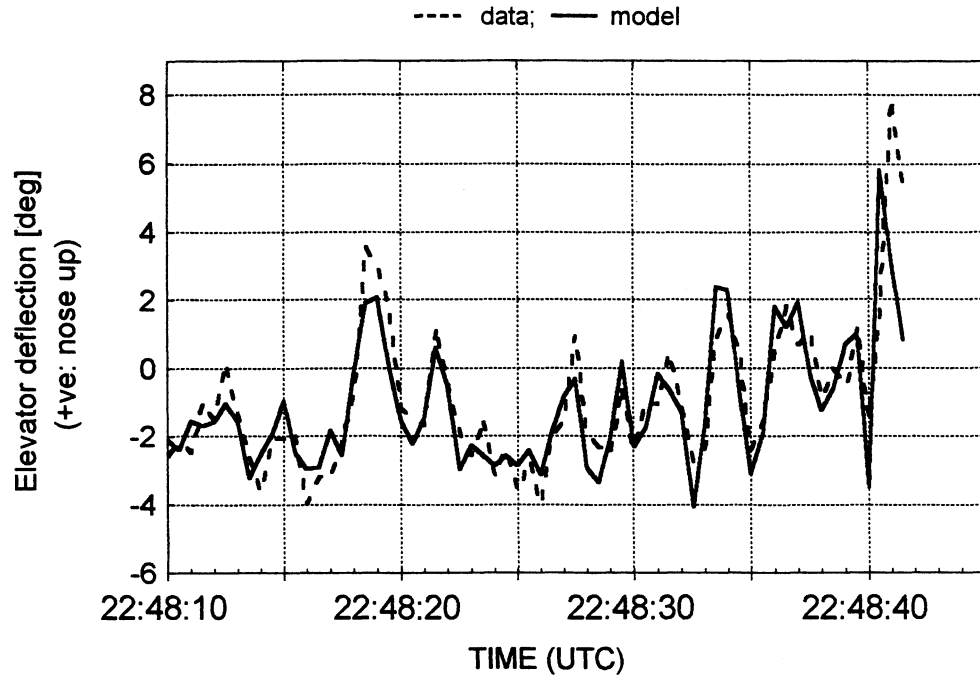

Figure 1 Comparison of model-computed and measured elevator deflection

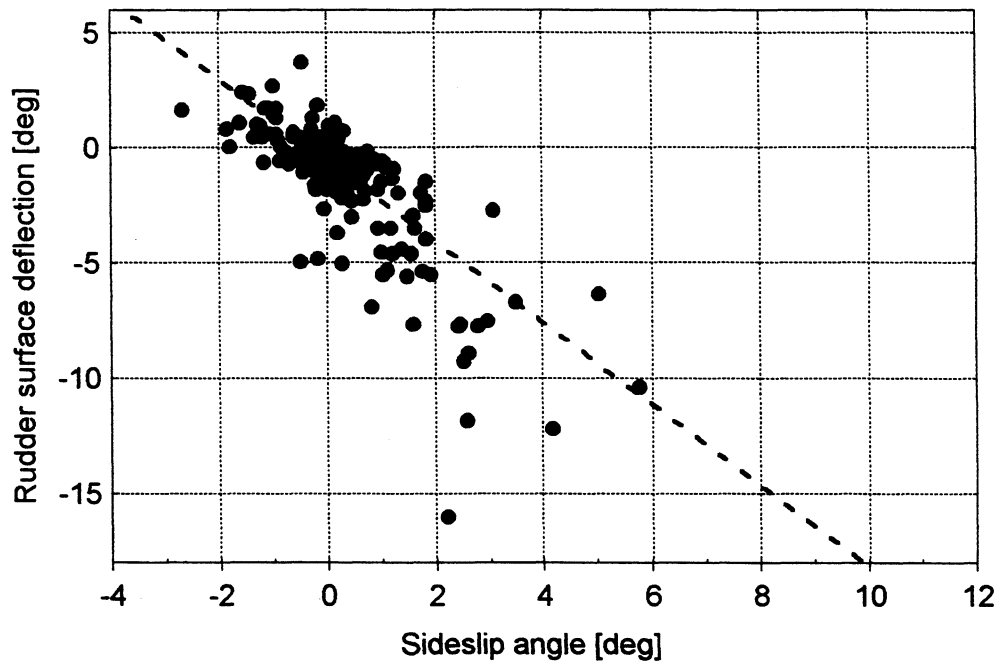

Figure 2 Correlation between sideslip angle and rudder surface deflection

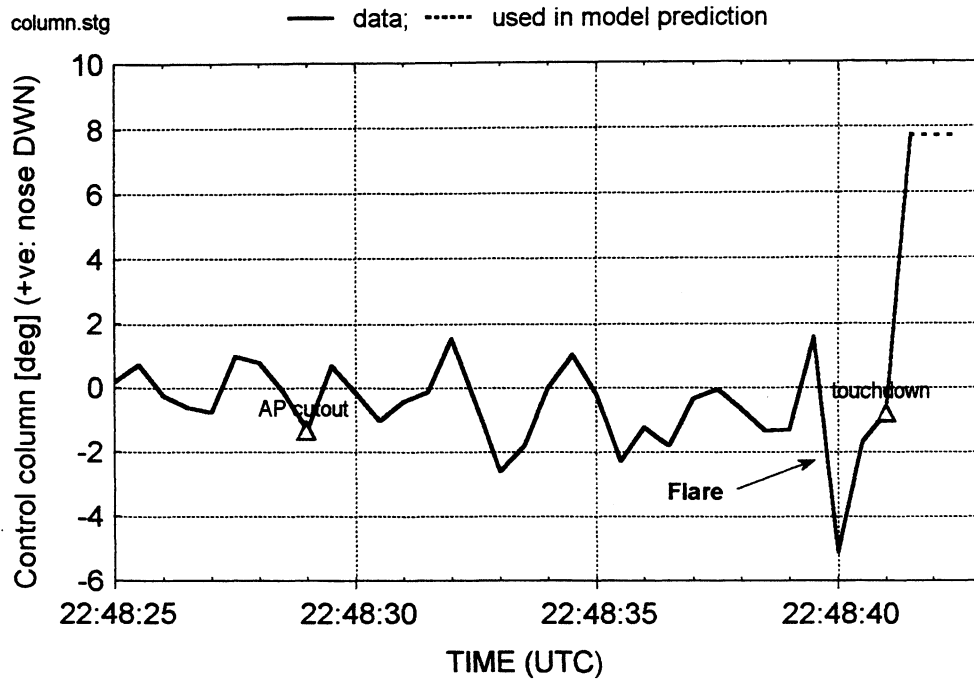

Figure 3 Control column deflection during approach, flare and landing

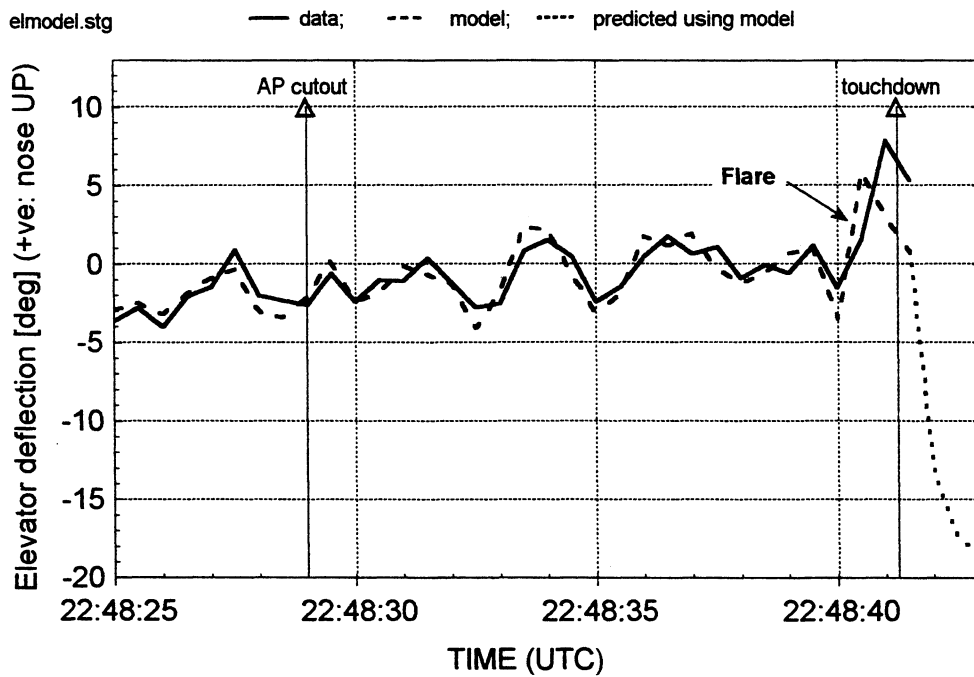

Figure 4 Elevator surface deflection (measured and predicted) during approach, flare and landing

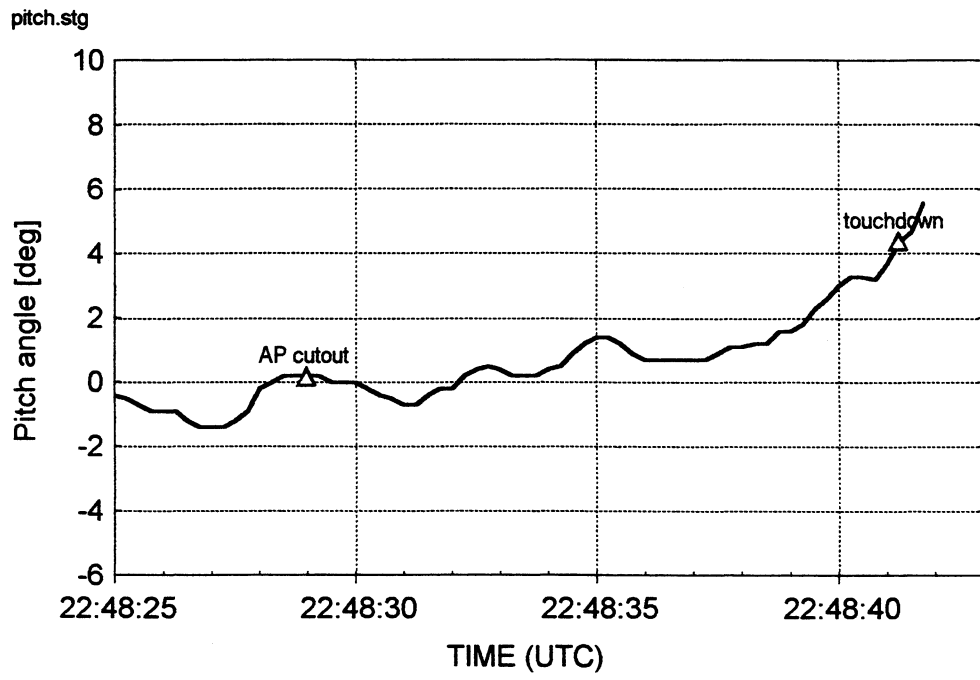

Figure 5 *Pitch angle response during flare and landing*

REPORT 97-75/A-26

APPENDIX 4

ATC Transcript

Bureau Operationele Zaken
 LUCHTVERKEERSBEVEILIGING
 Schiphol-Centrum

Referentie : BOZ 98/010

Datum : 07 januari 1998

RECORDERVERSLAG

Bandnummer : 1363 & 1365.

Kanaal : Band 1363: 9, 31 & 28; Band 1365: 20.

Frequentie : 125.75, 121.2, 119.22 & 118.1 MHz

Betreffende : Transavia 462 crash naast baan 19R Schiphol, d.d. 24 december 1997.

Bijzonderheden :

TRA = Transavia 462 KLM = KLM 791	ACC = ACC sector 4 TWR = Schiphol Tower	APP = Schiphol Approach FDR/DCO
--------------------------------------	--	------------------------------------

Tijd (UTC):	Tussen:	Inhoud:	Tijd (UTC):	Tussen:	Inhoud:
222546	TRA - ACC	Amsterdam radar good evening, Transavia 462, out of 280 descending 220			
222551	ACC - TRA	Goede avond Transavia 462, direct to 4 miles west abeam OA landing 19R and descend level 70			
222600	TRA - ACC	Eh... descending level 70 and 4 miles abeam eh. west abeam OA, Transavia 49.462			

TRA = Transavia 462 ACC = ACC sector 4 APP = Schiphol Approach
 KLM = KLM 791 TWR = Schiphol Tower FDR/DCO

Tijd (UTC)	Tussen:	Inhoud:	Tijd (UTC)	Tussen:	Inhoud:
222614	ACC - TRA	And 462 speed is all yours			
222622	TRA - ACC	Transavia 462 .eh.. we can delete the speed altitude restriction FI 100			
222625	ACC - TRA	Afirm speed is all yours			
222626	TRA - ACC	Thank you			
222629	TRA - ACC	I mean . below 100 is that okay?			
222631	ACC - TRA	It is all yours			
223316	ACC - TRA	Transavia 462, advise the speed now to Approach on 1212, wel thuis			
223331	ACC - TRA	Transavia 462, advise speed to Approach 1212, wel thuis			
223334	TRA - ACC	1212 and the speed, Transavia 462, daag			
223337	ACC - TRA	daag			
223340	TRA - APP	Approach good evening Transavia 462, out of level 110, descending 70, the speed 300 knots and we copied Echo	223326	ATIS	This is Schiphol Arrival information Echo Main landing runway 19R Transition level 45 220 degrees 31 knots, maximum 41 knots, minimum 21 knots Visibility 10 kilometers Few 2200ft, Scattered 2800ft Temperature 12, Dewpoint 9 QNH 1008 HPa NOSIG
223353	APP - TRA	Hello 462, proceed to abeam OA and it will be a right turn in for 19R with Echo			

TRA = Transavia 462 ACC = ACC sector 4 APP = Schiphol Approach
 KLM = KLM 791 TWR = Schiphol Tower FDR/DCO

Tijd (UTC):	Tussen:	Inhoud:	Tijd (UTC):	Tussen:	Inhoud:
223400	TRA - APP	Ehh... roger, west abeam we proceed, Transavia 462			
223401	APP - TRA	[click]			
223530	TRA - APP	Transavia 462 is approaching 70			
223532	APP - TRA	Thank you, maintain			
223534	TRA - APP	Maintain.. upon reaching, 462	223535	ATIS	This is Schiphol Arrival information Echo Main landing runway 19R Transition level 45 230 degrees 33 knots, variable between 200 and 260 degrees, maximum 45 knots, minimum 22 knots Visibility 10 kilometers Few 2200ft, Scattered 2800ft Temperature 12, Dewpoint 8 QNH 1008 Hpa NOSIG
223653	TRA - APP	And Transavia 462 is maintaining 70			
223656	APP - TRA	Roger			
223802	APP - TRA	Transavia 462, down to 3000 on 1008			
223805	TRA - APP	3000ft on 1008, Transavia 462			
223809	APP - TRA	Joe			
224030	APP - TRA	And Transavia 462, over right OA, leave 3 with the glide and cleared approach 19R			
224036	TRA - APP	Right.. OA and to leave 3 on the glide, cleared ILS 19R, Transavia 462			
224042	APP - TRA	Joe			
224325	APP - TRA	And 462, 9 miles, are you established?			
224329	TRA - APP	Eh.. now established, Transavia 462			
224331	APP - TRA	Nou mooi dan, naar de Toren, 11922, wel thuis			

TRA = Transavia 462 ACC = ACC sector 4 APP = Schiphol Approach
 KLM = KLM 791 TWR = Schiphol Tower FDR/DCO

Tijd (UTC):	Tussen:	Inhoud:	Tijd (UTC):	Tussen:	Inhoud:
224334	TRA - APP	1922, Transavia 462, dag mijnheer			
224336	APP - TRA	Daag			
224339	TRA - TWR	Tower, hello, Transavia 462, established ILS 19R			
224344	TWR - TRA	Transavia 462, hello, the wind is 240 30, maximum 43 knots*, cleared to land on 19R <i>* Deze wind is de digitale wind gepresenteerd aan de TWR-VKL op de Toren, een gemiddelde van de afgelopen 2 minuten, gemeten bij de hoofdlandingsbaan, t.w. baan 19R.</i>			
224350	TRA - TWR	Cleared to land 19R, Transavia 462			
224448	TRA - TWR	And Transavia 462,can we make a long landing?			
224452	TWR - TRA	Affirm			
224453	TRA - TWR	Dank u wel			
224454	TWR - TRA	C11 is the gate			
224455	TRA - TWR	Roger for C11	224500	KLM - TWR	Tower goede avond KLM 791 heavy approaching RWY 24
			224502	TWR - KLM	Hello KLM 791 line up runway 24
			224506	KLM - TWR	Line up and wait KLM 791
224648	TRA - ?	240 at 50 at 600 ft [stem v.d. gezagvoerder]	224653	KLM - TWR	KLM 791 is ready for departure 24
			224656	TWR - KLM	Thank you Sir, we are awaiting a landing on 19R first, stand-by
			224700	KLM - TWR	Yeah

TRA = Transavia 462 ACC = ACC sector 4 APP = Schiphol Approach
 KLM = KLM 791 TWR = Schiphol Tower FDR/DCO

Tijd (UTC):	Tussen:	Inhoud:	Tijd (UTC):	Tussen:	Inhoud:
224745	TWR - KLM	KLM 791, cleared for take-off runway 24 climb 90 stay on this	224750	KLM - TWR	Climb FL 90 to stay on this frequency, cleared take-off runway 24 and request windcheck. KLM 791...
224753	TWR - KLM	Wind is... <rest wordt door mayday call weggedrukt>	224823	TWR - APP	Op dit moment meldt de VKL de crash via de alarmtelefoon (NAAM), we hebben een crash op 19R
224825	APP - TWR	Wat ???	224829	TWR - APP	We hebben een crash op 19R, die Transavia
224831	TWR - KLM	KLM 791, we have an emergency, stand-by	224835	KLM - TWR	Standing by, cancelling take-off clearance. KLM 791
224846	?	[geruis... en later wat gekraak]			

